



**JEFFERSON COUNTY PURCHASING DEPARTMENT**  
*Deborah L. Clark, Purchasing Agent*

1149 Pearl Street  
1<sup>st</sup> Floor, Beaumont, TX 77701

OFFICE MAIN: (409) 835-8593  
FAX: (409) 835-8456

**LEGAL NOTICE**  
**Advertisement for Invitation for Bids**

October 22, 2024

Notice is hereby given that sealed bids will be accepted by the Jefferson County Purchasing Department for Invitation for Bid (IFB 24-064/MR) Popeye Holmes Park Concrete Walkway Renovation, pursuant to Chapter 262, Texas Local Government Code, the County Purchasing Act and 2 CFR Sections 200.318-326. Specifications for this project may be obtained from the Jefferson County website, <https://www.co.jefferson.tx.us/Purchasing/> or by calling 409-835-8593.

Bids are to be sealed and addressed to the Purchasing Agent with the bid number and name marked on the outside of the envelope or box. Bidders shall forward an original and two ( 2 ) copies of their bid to the address shown below. Jefferson County does not accept bids submitted electronically. Late bids will be rejected as non-responsive. Bids will be publicly opened and read aloud in the Jefferson County Engineering Department Conference Room (5th Floor, Historic Courthouse) 1149 Pearl Street, Beaumont, Texas 77701, at the time and date below. Bidders are invited to attend the sealed bid opening.

**BID NAME:** Popeye Holmes Park Concrete Walkway Renovation, pursuant to Chapter 262, Texas Local Government Code, the County Purchasing Act and 2 CFR Sections 200.318-326.

**BID NUMBER:** IFB 24-064/MR

+

**DUE BY TIME/DATE:** 11:00 AM CT, Wednesday, November 13, 2024

**MAIL OR DELIVER TO:** Jefferson County Purchasing Department  
1149 Pearl Street, 1<sup>st</sup> Floor  
Beaumont, Texas 77701

The County shall require the Bidder to furnish a Bid Security in the amount of five percent (5%) of the total contract cost. The bid bond must be executed with a surety company authorized to do business in the State of Texas.

Within ten (10) days after the date of contract execution and prior to the issuance of Notice to Proceed and/or Purchase Order, the Bidder shall furnish the following bonds: Performance Bond to the County for the full amount of the contract if the contract exceeds one hundred thousand dollars (\$100,000). Payment Bond to the County for the full amount of the contract if the contract exceeds twenty-five thousand dollars (\$25,000.00).

Any questions relating to these bid requirements should be directed to Mistey Reeves, Assistant Purchasing Agent at 409-835-8593 or via email at: [mistey.reeves@jeffcotx.us](mailto:mistey.reeves@jeffcotx.us). If no response in 72 hours, contact Deborah Clark, Purchasing Agent at 409-835-8593 or via email at: [deb.clark@jeffcotx.us](mailto:deb.clark@jeffcotx.us).

Jefferson County encourages Disadvantaged Business Enterprises (DBEs), Minority/Women Business Enterprises (M/WBEs), and Historically Underutilized Businesses (HUBs) to participate in the bidding process. Jefferson County does not discriminate on the basis of race, color, national origin, sex, religion, age or disability in employment, or the provisions of services. Individuals requiring special accommodations are requested to contact our office at least seven (7) days prior to the bid due date at 409-835-8593.

All interested firms are invited to submit a bid in accordance with the terms and conditions stated in this bid.

Bidders are strongly encouraged to carefully read the entire invitation, as failure to return and/or complete all required documentation will result in a response being declared as non-responsive.

Deborah L. Clark, Purchasing Agent  
Jefferson County, Texas

**PUBLISH:**  
**Beaumont Enterprise & Port Arthur News:**  
October 23, 2024 & October 30, 2024  
**The Examiner:**  
October 24, 2024

## TABLE OF CONTENTS

TABLE OF CONTENTS .....	1
SECTION 1: GENERAL CONDITIONS OF BIDDING AND TERMS OF CONTRACT .....	2
HUB, SBE, MBE OR WBE CERTIFICATION (INSERTION PAGE) .....	13
SECTION 2: FEMA MANDATED CONTRACT PROVISIONS .....	14
BYRD ANTI-LOBBYING CERTIFICATION FORM .....	24
DEBARMENT/SUSPENSION CERTIFICATION .....	25
CIVIL RIGHTS COMPLIANCE PROVISIONS .....	26
SECTION 3: SPECIAL REQUIREMENTS/BID SUBMISSION REQUIREMENTS .....	28
<u>INSERTION PAGE</u> : SYSTEM FOR AWARD MANAGEMENT (SAM) REGISTRATION PROOF .....	30
SAMPLE FORM 1295.....	32
<u>INSERTION PAGE</u> : FORM 1295 .....	33
SECTION 3 (CONTINUED): SPECIAL REQUIREMENTS/BID SUBMISSION REQUIREMENTS .....	34
<u>INSERTION PAGE</u> : CERTIFICATE OF INSURANCE (COI) PROOF.....	37
BIDDER INFORMATION FORM.....	38
SECTION 4: MINIMUM SPECIFICATIONS .....	39
AFFIDAVIT OF WARRANTY.....	44
OFFER TO CONTRACT FORM .....	45
ACCEPTANCE OF OFFER FORM.....	46
<u>INSERTION PAGE</u> : ADDENDA.....	47
+ <u>INSERTION PAGE</u> : BID SECURITY.....	48
BID FORM .....	49
VENDOR REFERENCES .....	50
SIGNATURE PAGE .....	51
CERTIFICATION REGARDING LOBBYING .....	52
CONFLICT OF INTEREST QUESTIONNAIRE .....	53
LOCAL GOVERNMENT OFFICER: CONFLICT DISCLOSURE STATEMENT FORM (OFFICE USE ONLY) .....	54
GOOD FAITH EFFORT DETERMINATION CHECKLIST .....	55
NOTICE OF INTENT .....	56
HUB SUBCONTRACTING PARTICIPATION DECLARATION FORM.....	57
RESIDENCE CERTIFICATION/TAX FORM.....	61
HOUSE BILL 89 VERIFICATION .....	62
SENATE BILL 252 CERTIFICATION .....	63
BID AFFIDAVIT .....	64
PROJECT PLANS .....	65

### **BID SUBMISSIONS:**

One (1) Original and two (2) Bid Copies; with all copies to include a Completed Copy of this specifications packet (**including technical specifications**), in its entirety.

Each Bidder shall ensure that required parts of their bid submission are completed with accuracy and submitted as per the requirements within this specifications packet, including any addenda.

Additionally, Bidder shall monitor the Jefferson County Purchasing Department Website for any addenda, additional instructions, or bid updates. <https://www.co.jefferson.tx.us/Purchasing/>

Failure to return and/or complete all required documentation **will result** in a response being declared as non-responsive.

## **SECTION 1: GENERAL CONDITIONS OF BIDDING AND TERMS OF CONTRACT**

---

By execution of this document, the Vendor accepts all general and special conditions of the contract as outlined below and, in the specifications, and plans.

### **1. BIDDING.**

#### **1.1 BIDS.**

All bids must be submitted on the bid form furnished in this package.

#### **1.2 AUTHORIZED SIGNATURES.**

The bid must be executed personally by the Vendor, duly authorized partner of the partnership, or duly authorized officer of the corporation. If executed by an agent, a power of attorney or other evidence of authority to act on behalf of the Vendor shall accompany the bid to become a valid bid.

#### **1.3 LATE BIDS.**

Bids must be in the office of the Jefferson County Purchasing Agent before or at the specified time and date bids are due. Bids received after the submission deadline shall be rejected as non-responsive and returned unopened.

#### **1.4 WITHDRAWAL OF BID PRIOR TO OPENING.**

A bid may be withdrawn before the opening date by submitting a written request to the Purchasing Agent. If time allows, the Bidder may submit a new bid. Bidder assumes full responsibility for submitting a new bid before or at the specified time and date bids are due. Jefferson County reserves the right to withdraw a request for bids before the opening date.

#### **1.5 WITHDRAWAL OF BID AFTER OPENING.**

Bidder agrees that its offer may not be withdrawn or cancelled by the Vendor for a period of ninety (90) days following the date and time designated for the receipt of bids unless otherwise stated in the bid and/or specifications.

#### **1.6 BID AMOUNTS.**

Bids shall show net prices, extensions where applicable and net total. In case of conflict between unit price and extension, the unit price will govern. Any ambiguity in the bid as a result of omission, error, unintelligible or illegible wording shall be interpreted in the favor of Jefferson County.

#### **1.7 EXCEPTIONS AND/OR SUBSTITUTIONS.**

All bids meeting the intent of the specifications and plans will be considered for award. Vendors taking exception to the specifications and plans, or offering substitutions, shall state these exceptions in the section provided. If bid is made on an article other than the one specified, which a Bidder considers comparable, the name and grade of said article must be specified in the bid and sufficient specifications and descriptive data must accompany same to permit thorough evaluation. The absence of stated exceptions and/or substitutions shall indicate that the Vendor has not taken any exceptions to the specifications and shall be responsible to perform in strict accordance with the specifications. As a matter of practice, Jefferson County rejects exception(s) and /or substitutions as non-responsive but reserves the right to accept any and/or all of the exception(s) and/or substitution(s) deemed to be in the best interest of Jefferson County.

#### **1.8 ALTERNATES.**

The Invitation for Bid and/or specifications may expressly allow Bidder to submit an alternate bid. Presence of such an offer shall not be considered an indication of non-responsiveness.

**1.9 DESCRIPTIONS.**

Unless otherwise specified, any reference to make, manufacturer and/or model used in the bid specifications is merely descriptive and not restrictive, and is used only to indicate type, style, or quality of material desired.

**1.10 BID ALTERATIONS.**

Bids cannot be altered or amended after submission deadline. Any interlineations, alterations, or erasures made before opening time must be initialed by the signer of the bid, guaranteeing authenticity.

**1.11 TAX EXEMPT STATUS.**

Jefferson County is exempt from federal excise tax and state sales tax. Unless the bid form or specifications specifically indicate otherwise, the bid price must be net, exclusive of above-mentioned taxes and will be so construed. Therefore, the bid price shall not include taxes.

**1.12 QUANTITIES.**

Quantities indicated are estimated quantities only and are not a commitment to buy. Approximate usage does not constitute an order, but only implies the probable quantity that will be used. Commodities will be ordered on an as-needed basis. Bidder is responsible for accurate final counts.

**1.13 BID AWARD.**

Award of contract shall be made to the most responsible, responsive Bidder, whose offer is determined to be the best value, taking into consideration the relative importance of price. Jefferson County reserves the right to be the sole judge as to whether items bid will serve the purpose intended.

Jefferson County reserves the right to award based upon individual line items, sections or total bid.

**1.14 SILENCE OF SPECIFICATIONS FOR COMPLETE UNITS.**

All materials, equipment and/or parts that will become a portion of the completed work, including items not specifically stated herein but, necessary to render the service(s) complete and operational per the specifications, are to be included in the bid price. Vendor may be required to furnish evidence that the service, as bid, will meet or exceed these requirements.

**1.15 ADDENDA.**

Any interpretations, corrections or changes to the specifications and plans will be made by addenda no later than forty-eight (48) hours prior to the bid opening. Addenda will be posted on the Purchasing web site. Vendors are responsible for monitoring the web site in order to remain informed on addenda. Vendors shall acknowledge receipt of all addenda with submission of bid.

**1.16 GENERAL BID BOND/SURETY REQUIREMENTS.**

Failure to furnish bid bond/surety, if requested, will result in bid being declared non-responsive. Non-responsive bids will not be considered for award.

**1.17 GENERAL INSURANCE REQUIREMENTS.**

Failure to furnish Affidavit of Insurance, if required in these specifications, will result in bid being declared non-responsive. Non-responsive bids will not be considered for award.

**1.18 RESPONSIVENESS.**

A responsive bid shall substantially conform to the requirements of this Invitation to Bid and/or specifications contained herein. Bidders who substitute any other terms, conditions, specifications and/or requirements or who qualify their bids in such a manner as to nullify or limit their liability to the contracting entity shall have their bids deemed non-responsive. Also, bids containing any clause that would limit contracting authority shall be considered non-responsive. Examples of non-responsive bids include but shall not be limited to: a) bids that fail to conform to

required delivery schedules as set forth in the bid request; b) bids with prices qualified in such a manner that the bid price cannot be determined, such as with vague wording that may include "price in effect at the time of delivery," and c) bids made contingent upon award of other bids currently under consideration.

**1.19 RESPONSIBLE STANDING OF BIDDER.**

To be considered for award, Bidder must at least: have the ability to obtain adequate financial resources, be able to comply with required or proposed delivery/completion schedule, have a satisfactory record of performance; have a satisfactory record of integrity and ethics, and be otherwise qualified and eligible to receive award.

**1.20 CONFIDENTIAL/PROPRIETARY INFORMATION.**

If any material in the bid submission is considered by Bidder to be confidential or proprietary information (including manufacturing and/or design processes exclusive to the Bidder), Bidder **must** clearly mark the applicable pages of bid submission to indicate each claim of confidentiality. Additionally, Bidder must include a statement on company letterhead identifying all Bid Submission section(s) and page(s) that have been marked as confidential. Jefferson County will protect from public disclosure such portions of a bid, unless directed otherwise by legal authority, including existing open records acts. Merely making a blanket claim that the entire bid submission is protected from disclosure because it contains some proprietary information is not acceptable, and will make the entire bid submission subject to release under the Texas Public Information Act.

By submitting a bid, Bidder agrees to reproduction by Jefferson County, without cost or liability, of any copyrighted portions of Bidder's bid submission or other information submitted by Bidder.

**1.21 PUBLIC BID OPENING.**

Bidders are invited to be present at the opening of bids. After the official opening of bids, a period of not less than one week is necessary to evaluate bids. The amount of time necessary for bid evaluation may vary and is determined solely by the County. Following the bid evaluation, all bids submitted are available for public review.

**2. PERFORMANCE.**

**2.1 DESIGN, STRENGTH, AND QUALITY.**

Design, strength, and quality of materials and workmanship must conform to the highest standards of manufacturing and engineering practices. The apparent silence of specifications and/or plans as to any detailed description concerning any point shall be regarded as meaning that only the best commercial practices are to prevail. All interpretations of these specifications and/or plans shall be made on the basis of this statement.

**2.2 AGE AND MANUFACTURE.**

All tangible goods being bid must be new and unused, unless otherwise specified, in first-class condition, of current manufacture, and furnished ready to use. All items not specifically mentioned that are required for a complete unit shall be furnished.

**2.3 DELIVERY LOCATION.**

All deliveries will be made to the address(es) specified on the purchase order during normal office working hours of 8:00 am CT to 4:00 pm CT, Monday through Friday, unless otherwise authorized by the Purchasing Agent or designee.

**2.4 DELIVERY SCHEDULE.**

Delivery time may be an important consideration in the evaluation of best value. The maximum number of days necessary for delivery ARO shall be stated in the space, if provided, on the bid form.

**2.5 DELIVERY CHARGES.**

All delivery and freight charges, F.O.B. destination shown on Jefferson County purchase order, as necessary to perform contract are to be included in the bid price.

## **2.6 INSTALLATION CHARGES.**

All charges for assembly, installation and set-up shall be included in the bid price. Unless otherwise stated, assembly, installation and set-up will be required.

## **2.7 OPERATING INSTRUCTIONS AND TRAINING.**

Clear and concise operating instructions and descriptive literature will be provided in English, if requested. On-site detailed training in the safe and efficient use and general maintenance of item(s) purchased shall be provided as needed at the request of Jefferson County. Instructions and training shall be at no additional cost to the County.

## **2.8 STORAGE.**

Bidder agrees to provide storage of custom ordered materials, if requested, for up to thirty (30) calendar days.

## **2.9 COMPLIANCE WITH FEDERAL, STATE, COUNTY, AND LOCAL LAWS.**

Bids must comply with all federal, state, county and local laws, including, but not limited to, all applicable standard safety, emission, and noise control requirements. Any vehicles or equipment shall contain all standard safety, emission, and noise control requirements required for the types and sizes of equipment at the time of their manufacture. The Contractor agrees, during the performance of work or service, to comply with all applicable codes and ordinances of Jefferson County or the State of Texas as they may apply, as these laws may now read, or as they may hereafter be changed or amended.

## **2.10 OSHA.**

The Bidder will certify all equipment complies with all regulations and conditions stipulated under the Williams-Steiger Occupational Safety and Health Act of 1971, as amended. The successful Bidder will further certify that all items furnished under this project will conform and comply with federal and State of Texas OSHA standards. The successful Bidder will agree to indemnify and hold harmless Jefferson County for any and all damages that may be assessed against the County.

## **2.11 PATENTS AND COPYRIGHTS.**

The successful Vendor agrees to protect the County from claims involving infringements of patents and/or copyrights.

## **2.12 SAMPLES, DEMONSTRATIONS, AND TESTING.**

At Jefferson County's request and direction, Bidder shall provide product samples and/or testing of items bid to ensure compliance with specifications. Samples, demonstrations and/or testing may be requested at any point prior to or following bid award. Samples, demonstrations and/or testing may be requested upon delivery and/or any point during the term of resulting contract. All samples (including return thereof), demonstrations, and/or testing shall be at the expense of the Bidder/Vendor.

## **2.13 ACCEPTABILITY.**

All articles enumerated in the bid shall be subject to inspection by an officer designated for that purpose by Jefferson County. If found inferior to the quality called for, or not equal in value to the specifications, deficient in workmanship or otherwise, this fact shall be certified to the Purchasing Agent, who shall have the right to reject the whole or any part of the same. Items and/or work determined to be contrary to specifications must be replaced at the vendor's expense. Inferior items not retrieved by the vendor within thirty (30) calendar days, or an otherwise agreed upon time, shall become the property of the County. If disposal of such items warrants an expense, an amount equal to the disposal expense will be deducted from amounts payable to the vendor.

## **2.14 MAINTENANCE.**

Maintenance required for equipment bid should be available in Jefferson County by a manufacturer authorized maintenance facility. Cost for this service shall be shown on the bid sheet as requested or on a separate sheet, as required. If Jefferson County opts to include maintenance, it shall be so stated in the purchase order and said cost will be included. Service will commence only upon expiration of applicable warranties and should be priced

accordingly.

### **2.15 MATERIAL SAFETY DATA SHEETS.**

Under the "Hazardous Communications Act," common known as the "Texas Right to Know Act," a Bidder must provide the user department, with each delivery, material safety data sheets which are applicable to hazardous substances defined in the Act. Failure of the Bidder to furnish this documentation, will be cause to reject any bid applying thereto.

### **2.16 EVALUATION.**

Evaluation shall be used as a determinant as to which services are the most efficient and/or most economical for the County. It shall be based on all factors having a bearing on price and performance of the items in the user environment. All bids are subject to tabulation by the Jefferson County Purchasing Department and recommendation to Jefferson County Commissioners' Court. Compliance with all bid requirements and needs of the using department are considered in evaluating bids. Pricing is not the only criteria for making a recommendation. The Jefferson County Purchasing Department reserves to right to contact any Bidder, at any time, to clarify, verify or requirement information with regard to this bid.

## **3. PURCHASE ORDERS AND PAYMENT.**

### **3.1 PURCHASE ORDERS.**

A purchase order(s) shall be generated by the Jefferson County Purchasing Agent to the successful vendor. The purchase order number must appear on all itemized invoices and packing slips. The County will not be held responsible for any work orders placed and/or performed without a valid current purchase order number. Payment will be made for all services rendered and accepted by the contract administrator for which a valid invoice has been received.

### **3.2 INVOICES.**

All invoices shall reference the Purchase Order number. Invoices shall reference the bid item number or a detailed description for each item invoiced. If an item purchased and itemized on the invoice does not correspond to an item in any of the categories awarded to the vendor, invoice shall reference the item as "N/C" to indicate that it is a non-contract item. This requirement is to assist the County in verifying contract pricing on all invoices. Payment will be made under terms of net thirty (30) days unless otherwise agreed upon by seller and the purchasing department.

### **3.3 PROMPT PAYMENT.**

In accordance with the State of Texas Prompt Payment Act, Article 601f V.T.C.S., payment will be made after receive and acceptance by the County of the merchandise ordered and of a valid invoice. Successful Bidder(s) is required to pay Subcontractors within ten (10) days after the successful Bidder receives payment from the County.

### **3.4 FUNDING.**

Jefferson County is operated and funded on an October 1 to September 30 basis; accordingly, the County reserves the right to terminate, without liability to the County, any contract for which funding is not available.

## **4. CONTRACT.**

### **4.1 CONTRACT DEFINITION.**

The General Conditions of Bidding and Terms of Contract, Specifications, Plans, Bidding Forms, Addenda, and any other documents made a part of this bid shall constitute the complete bid. This bid, when duly accepted by Jefferson County, shall constitute a contract equally binding between the successful Bidder and Jefferson County.

### **4.2 CHANGE ORDER.**

No different or additional terms will become part of this contract with the exception of a change order. No oral statement of any person shall modify or otherwise change, or affect the terms, conditions or specifications stated in

the resulting contract. All change orders to the contract will be made in writing and at the discretion and approval of Jefferson County. No change order will be binding unless signed by an authorized representative of the County and the vendor.

#### **4.3 PRICE RE-DETERMINATION.**

A price re-determination may be requested at the time of annual renewal. All requests for price re-determination shall be in written form. Cause for such request, i.e., manufacturer's direct cost, postage rates, Railroad Commission rates, Federal/State minimum wage law, Federal/State unemployment taxes, F.I.C.A, Insurance Coverage Rates, etc., shall be substantiated in writing by the source of the cost increase. The Bidder's past experience of honoring contracts at the bid price will be an important consideration in the evaluation of the lowest and best bid. Jefferson County reserves the right to accept or reject any/all requests for price re-determination as it deems to be in the best interest of the County.

#### **4.4 TERMINATION.**

Jefferson County reserves the right to terminate the contract for default if the Bidder breached any of the terms therein, including warranties of Bidder or if the Bidder becomes insolvent or commits acts of bankruptcy. Such right of termination is in addition to and not in lieu of any other remedies which Jefferson County may have in law or equity. Default may be construed as, but not limited to, failure to deliver the proper goods and/or service within the proper amount of time, and/or to properly perform any and all services required to Jefferson County's satisfaction and/or to meet all other obligations and requirements. Contracts may be terminated without cause upon thirty (30) days' written notice to either party unless otherwise specified. Jefferson County reserves the right to award canceled contract to the next lowest Bidder. Bidder, in submitting this bid, agrees that Jefferson County shall not be liable to prosecution for damages in the event that the County declares the Bidder in default.

#### **4.5 CONFLICT OF INTEREST.**

Employees of the County are not permitted to maintain financial interest in, or receive payment, directly or indirectly, borrow from, lend to, invest in, or engage in any substantial financial transaction with any individual, organization, supplier, or Subcontractor who does business with the County without disclosure. When conflict of interest is discovered, it shall be grounds for termination of contract.

#### **4.6 INTEREST BY PUBLIC OFFICIALS.**

No public official shall have interest in this contract, in accordance with Texas Local Government Code.

#### **4.7 PRE-AWARD/CONTRACT CONTACT BETWEEN COUNTY AND VENDORS.**

**The Jefferson County Purchasing Department may initiate discussions with selected vendors; however, discussions may not be initiated by vendors.**

The Jefferson County Purchasing Department expects to conduct discussions with vendor's representatives authorized to contractually obligate the vendor with an offer.

**Vendors shall not contact any Jefferson County personnel during the IFB process without the express permission from the Jefferson County Purchasing Agent. The Purchasing Agent will disqualify any vendor who has made site visits, contacted Jefferson County personnel, or distributed any literature without authorization from the Jefferson County Purchasing Department.**

**All correspondence relating to this IFB, from advertisement to award shall be sent to the Jefferson County Purchasing Department. All presentations and/or meetings between Jefferson County and the vendor relating to this IFB shall be coordinated by the Jefferson County Purchasing Department.**

Selected vendors may be expected to make a presentation/product demonstration to an Evaluation Committee. Proposals, vendor presentations, and product/service evaluations may develop into negotiating sessions with the



vendor(s) as selected by the Evaluation Committee. Jefferson County expects to conduct negotiations with vendor representatives authorized to contractually obligate the vendor with an offer. If vendor is unable to agree to contract terms and conditions, Jefferson County reserves the right to terminate contract negotiations with that vendor and initiate negotiations with another vendor. In addition to a presentation, visits by the Evaluation Committee to representative vendor client sites may be conducted where the proposed solution can be demonstrated in a production environment.

**4.8 INJURIES OR DAMAGES RESULTING FROM NEGLIGENCE.**

Successful vendor shall defend, indemnify and save harmless Jefferson County and all its officers, agents and employees from all suits, actions, or other claims of any character, name and description brought for or on account of any injuries or damages received or sustained by any person, persons, or property on account of any negligent act or fault of the successful vendor, or of any agent, employee, Subcontractor or supplier in the execution of, or performance under, any contract which may result from bid award. Successful vendor shall pay any judgment with cost which may be obtained against Jefferson County growing out of such injury or damages.

**4.9 WARRANTY.**

The successful vendor shall warrant that all materials utilized in the performance of this contract shall conform to the proposed specifications and/or all warranties as stated in the Uniform Commercial Code and be free from all defects in material, workmanship and title.

**4.10 UNIFORM COMMERCIAL CODE.**

The successful vendor and Jefferson County agree that both parties have all rights, duties, and remedies available as stated in the Uniform Commercial Code.

**4.11 VENUE.**

This agreement will be governed and construed according to the laws of the State of Texas. This agreement is performable in the County of Jefferson, Texas.

**4.12 SALE, ASSIGNMENT, OR TRANSFER OF CONTRACT.**

The successful vendor shall not sell, assign, transfer or convey this contract, in whole or in part, without the prior written consent of Jefferson County.

**4.13 SILENCE OF SPECIFICATIONS.**

The apparent silence of these specifications as to any detailed description concerning any point, shall be regarded as meaning that only the best commercial practices are to prevail. All interpretations of these specifications shall be made on the basis of this statement.

**5. REJECTION OR WITHDRAWAL.**

Submission of additional terms, conditions or agreements with the bid document are grounds for deeming a bid non-responsive and may result in bid rejection. Jefferson County reserves the right to reject any and all bids and to waive any informalities and minor irregularities or defects in bids. Bids may be withdrawn in person by a bidder or authorized representative, provided their identity is made known and a receipt is signed for the bid, but only if the withdrawal is made prior to the time set for receipt of bids. Bids are an irrevocable offer and may not be withdrawn within 90 days after opening date.

**6. EMERGENCY/DECLARED DISASTER REQUIREMENTS.**

In the event of an emergency or if Jefferson County is declared a disaster area, by the County, State, or Federal Government, this Acceptance of Offer may be subjected to unusual usage. Contractor shall service the county during such an emergency or declared disaster under the same terms and conditions that apply during non-emergency/disaster conditions. The pricing as specified in this Acceptance of Offer shall apply to serving the County's needs regardless of the circumstances. If Contractor is unable to supply the services under the terms of the

Acceptance of Offer, then Contractor shall provide proof of such disruption and a copy of the invoice from Contractor's supplier(s).

Additional profit margin as a result of supplying services during an emergency or declared disaster shall not be permitted. In the event that additional equipment, supplies, and materials are required during the declared disaster, additional shipping, handling and drayage fees may apply.

#### **7. AWARD.**

The bid will be awarded to the responsible, responsive bidder(s) whose bid, conforming to the solicitation, will be most advantageous to Jefferson County – price and other factors considered. Unless otherwise specified in this IFB, Jefferson County reserves the right to accept a bid in whole or in part, and to award by item or by group, whichever is deemed to be in the best interest of Jefferson County. Any bidder who is in default to Jefferson County at the time of submittal of the bid shall have that bid rejected.

Jefferson County reserves the right to clarify any contractual terms with the concurrence of the Contractor; however, any substantial non-conformity in the offer, as determined by Jefferson County, shall be deemed non-responsive and the offer rejected.

In evaluating bids, Jefferson County shall consider the qualifications of the bidders, and, where applicable, operating costs, delivery time, maintenance requirements, performance data, and guarantees of materials and equipment.

In addition, Jefferson County may conduct such investigation as it deems necessary to assist in the evaluation of a bid and to establish the responsibility, qualifications, and financial ability of the bidders to fulfill the contract.

Jefferson County reserves the right to award this contract on the basis of **lowest and best bid** in accordance with the laws of the State of Texas, to waive any formality or irregularity, to make awards to more than one offeror, and/or to reject any or all bids. In the event the lowest dollar offeror meeting specifications is not awarded a contract, Offeror may appear before the Commissioners' Court and present evidence concerning Offeror responsibility after officially notifying the Office of the Purchasing Agent of Offeror's intent to appear.

#### **8. CONTRACT.**

A response to an IFB is an offer to contract with Jefferson County based upon the terms, conditions, and specifications contained in the IFB. Bids do not become contracts unless and until they are executed by Jefferson County, eliminating a formal signing of a separate contract. For that reason, all of the terms and conditions of the contract are contained in the IFB, unless any of the terms and conditions is modified by an IFB Amendment, a Contract Amendment, or by mutually agreed terms and conditions in the contract documents.

#### **9. WAIVER OF SUBROGATION.**

Bidder and bidder's insurance carrier waive any and all rights whatsoever with regard to subrogation against Jefferson County as an indirect party to any suit arising out of personal or property damages resulting from bidder's performance under this agreement.

#### **10. FISCAL FUNDING.**

A multi-year contract (if requested by the specifications) continuing as a result of an extension option must include fiscal funding out. If, for any reason, funds are not appropriated to continue the contract, said contract shall become null and void.

#### **11. BID RESULTS.**

Bid results are not provided in response to telephone inquiries. A preliminary tabulation of bids received will be posted on the Purchasing web page at <https://www.co.jefferson.tx.us/Purchasing/> as soon as possible following bid opening. A final tabulation will be posted following bid award, and will also be available for review in the Purchasing

Department.

**12. CHANGES AND ADDENDA TO BID DOCUMENTS.**

Each change or addendum issued in relation to this IFB document will be on file in the Office of the Purchasing Agent, and will be posted on the Purchasing web site as soon as possible. It shall be the bidder's responsibility to make inquiry as to change or addenda issued, and to monitor the web site. All such changes or addenda shall become part of the contract and all bidders shall be bound by such addenda. Information on all changes or addenda issued will be available at the Office of the County Purchasing Agent.

**13. SPECIFICATIONS.**

Unless otherwise stated by the bidder, the bid will be considered as being in accordance with Jefferson County's applicable standard specifications, and any special specifications outlined in the bid document. References to a particular trade name, manufacturer's catalogue, or model number are made for descriptive purposes to guide the bidder in interpreting the requirements of Jefferson County, and should not be construed as excluding bids on other types of materials, equipment, and supplies. However, the bidder, if awarded a contract, will be required to furnish the particular item referred to in the specifications or description unless departure or substitution is clearly noted and described in the bid.

Jefferson County reserves the right to determine if equipment/ product being bid is an acceptable alternate. All goods shall be new unless otherwise so stated in the bid. Any unsolicited alternate bid, or any changes, insertions, or omissions to the terms and conditions, specifications, or any other requirements of the bid, may be considered non-responsive.

**14. DELIVERY.**

**Bids shall include all charges for delivery, packing, crating, containers, etc. Unless otherwise stated by the bidder (in writing on the included Bid Form), prices bid will be considered as being based on F.O.B. destination/delivered freight included.**

**15. INTERPRETATION OF BID AN/OR CONTRACT DOCUMENTS.**

All inquiries shall be made within a reasonable time prior to the date and time fixed for the bid opening, in order that a written response in the form of an addendum, if required, can be processed before the bids are opened. Inquiries received that are not made in a timely fashion may or may not be considered.

**16. CURRENCY.**

Prices calculated by the bidder shall be stated in U.S. dollars.

**17. PRICING.**

Prices shall be stated in units of quantity specified in the bid documents. In case of discrepancy in computing the amount of the bid, the unit price shall govern.

**18. NOTICE TO PROCEED/PURCHASE ORDER.**

The successful bidder may not commence work under this contract until authorized to do so by the Purchasing Agent.

**19. CERTIFICATION.**

**By signing the offer section of the Offer and Acceptance page, Bidder certifies:**

- The submission of the offer did not involve collusion or other anti-competitive practices.
- The Bidder has not given, offered to give, nor intends to give at any time hereafter, any economic opportunity, future employment, gift, loan, gratuity, special discount, trip, favor, or service to any public servant in connection with the submitted offer.

- The Bidder hereby certifies that the individual signing the bid is an authorized agent for the Bidder and has the authority to bind the Bidder to the contract.

## 20. DEFINITIONS.

“County” – Jefferson County, Texas.

“Contractor” – The Bidder whose proposal is accepted by Jefferson County.

## 21. SMALL, MINORITY & WOMEN BUSINESS ENTERPRISE PARTICIPATION

It is the desire of Jefferson County to increase the participation of Small, Minority (MBE) and women-owned (WBE) businesses in its contracting and procurement programs. While the County does not have any preference or set aside programs in place, it is committed to a policy of equitable participation for these firms.

Minority owned business may be eligible for contract procurement assistance with public and private sector entities from MBDA Centers

### **Dallas Fort Worth MBDA Business Center**

8828 N. Stemmons Freeway, Ste. 550 B

Dallas, TX 75247

214-920-2436

Website: <https://www.mbdadfw.com>

Email: [admin1@mbdadallas.com](mailto:admin1@mbdadallas.com)

### **El Paso MBDA Business Center**

2401 East Missouri Avenue

El Paso, TX 79903

915-351-6232

Website: <https://www.mbda.gov/business-center/el-paso-mbda-business-center>

Email: [treed@ephcc.org](mailto:treed@ephcc.org)

### **Houston MBDA Business Center**

3100 Main Street, Ste. 701

Houston, TX 77002

713-718-8974

Website: <https://www.mbda.gov/business-center/houston-mbda-business-center>

Email: [mbda@hccs.edu](mailto:mbda@hccs.edu)

### **San Antonio MBDA Business Center**

501 W. Cesar E. Chavez Blvd., Ste. 3.324 B

San Antonio, TX 78207

210-458-2480

Website: <https://www.mbda.gov/business-center/san-antonio-mbda-business-center>

Email: [Jacqueline.jackson@utsa.edu](mailto:Jacqueline.jackson@utsa.edu)

Small and woman-owned business may be eligible for assistance from U.S. Small Business Administration (SBA):

Website: <https://www.sba.gov/local-assistance>

**Dallas/Fort Worth District Office**

150 West Parkway, Ste. 130

Eules, TX 76040

817-684-5500

Website: <https://www.sba.gov/district/dallas-fort-worth>

Email: [dfwdo.email@sba.gov](mailto:dfwdo.email@sba.gov)

**El Paso District Office**

211 N. Florence St, Ste. 201

El Paso, TX 79901

915-834-4600

Website: <https://www.sba.gov/district/el-paso>

Email: [Suzanne.aguirre@sba.gov](mailto:Suzanne.aguirre@sba.gov)

**Houston District Office**

8701 S. Gessner Dr, Ste. 1200

Houston, TX 77074

713-773-6500

Website: <https://www.sba.gov/district/houston>

Email: [houston@sba.gov](mailto:houston@sba.gov)

**Lower Rio Grande Valley District Office**

2422 E. Tyler Ave, Suite E

Harlingen, TX 78550

956-427-8533

Website: <https://www.sba.gov/district/lower-rio-grande-valley>

Email: [lrgvdo.email@sba.gov](mailto:lrgvdo.email@sba.gov)

**San Antonio District Office**

615 E. Houston St, Ste 298

San Antonio, TX 78205

210-403-5900

Website: <https://www.sba.gov/district/san-antonio>

Email: [sado.email@sba.gov](mailto:sado.email@sba.gov)

**West Texas District Office**

1205 Texas Ave, Room 408

Lubbock, TX 79401

806-472-7462

Website: <https://www.sba.gov/district/west-texas>

Email: [lubdo@sba.gov](mailto:lubdo@sba.gov)

HUB certification information can be found at:

**Statewide Procurement Division HUB Program**

P.O. Box 13528

Austin, TX 78711

512-463-5872 or 888-863-5881

Website: <https://comptroller.texas.gov/purchasing/vendor/hub>

Email: [statewidehubprogram@cpa.texas.gov](mailto:statewidehubprogram@cpa.texas.gov)

**PROPOSER: INSERT HUB, SBE, MBE or WBE Certification behind this page.**

**SECTION 2: FEDERAL EMERGENCY MANAGEMENT AGENCY (FEMA)  
MANDATED CONTRACT PROVISIONS FOR NON-FEDERAL ENTITY UNDER FEDERAL AWARDS  
REQUIRED BY 2 C.F.R. §200.326 APPENDIX II TO 2 CFR §200**

2 CFR 200.327 Contract provisions. The non-Federal entity’s contracts should contain applicable provisions described in Appendix II to Part 200—Contract Provisions for non-Federal Entity Contracts Under Federal Awards. The non-Federal entity’s contracts must contain the provisions described in Appendix II to Part 200—Contract Provisions for non-Federal Entity Contracts Under Federal Awards, as applicable. **\*Language as of August 31, 2022.**

THRESHOLD	PROVISION	CITATION
<p>&gt;\$250,000 (Simplified Acquisition Threshold)</p>	<p>Contracts for more than the simplified acquisition threshold, which is the inflation adjusted amount determined by the Civilian Agency Acquisition Council and the Defense Acquisition Regulations Council (Councils) as authorized by <a href="#">41 U.S.C. 1908</a>, must address administrative, contractual, or legal remedies in instances where Contractors violate or breach contract terms, and provide for such sanctions and penalties as appropriate.</p>	<p>2 CFR 200 APPENDIX II (A)</p>
<p>&gt;\$10,000</p>	<p>All contracts in excess of \$10,000 must address termination for cause and for convenience by the non-Federal entity including the manner by which it will be affected and the basis for settlement.</p>	<p>2 CFR 200 APPENDIX II (B)</p>
<p>None</p>	<p>Equal Employment Opportunity. Except as otherwise provided under <a href="#">41 CFR Part 60</a>, all contracts that meet the definition of “federally assisted construction contract” in <a href="#">41 CFR Part 60-1.3</a> must include the equal opportunity clause provided under <a href="#">41 CFR 60-1.4(b)</a>, in accordance with Executive Order 11246, “Equal Employment Opportunity” (<a href="#">30 FR 12319, 12935, 3 CFR Part, 1964-1965 Comp., p. 339</a>), as amended by Executive Order 11375, “Amending Executive Order 11246 Relating to Equal Employment Opportunity,” and implementing regulations at <a href="#">41 CFR part 60</a>, “Office of Federal Contract Compliance Programs, Equal Employment Opportunity, Department of Labor.”</p> <p>41 CFR 60-1.4 Equal opportunity clause.</p> <p>(b) Federally assisted construction contracts. (1) Except as otherwise provided, each administering agency shall require the inclusion of the following language as a condition of any grant, contract, loan, insurance, or guarantee involving federally assisted construction which is not exempt from the requirements of the equal opportunity clause:</p> <p>The [recipient] hereby agrees that it will incorporate or cause to be incorporated into any contract for construction work, or modification thereof, as defined in the regulations of the Secretary of Labor at 41 CFR Chapter 60, which is paid for in whole or in part with funds obtained from the Federal Government or borrowed on the credit of the Federal Government pursuant to a grant, contract, loan, insurance, or guarantee, or undertaken pursuant to any Federal program involving such grant, contract, loan, insurance, or guarantee, the following equal opportunity clause:</p> <p>During the performance of this contract, the Contractor agrees as follows:</p> <p>(1) The Contractor will not discriminate against any employee or applicant for employment because of race, color, religion, sex, sexual orientation, gender identity, or national origin. The Contractor will take affirmative action to ensure that applicants are employed, and that employees are treated during employment without regard to their race, color, religion, sex, sexual orientation, gender identity, or national origin. Such action shall include, but not be limited to the following:</p>	<p>2 CFR 200 APPENDIX II I and 41 CFR §60-1.4(b)</p>

Employment, upgrading, demotion, or transfer; recruitment or recruitment advertising; layoff or termination; rates of pay or other forms of compensation; and selection for training, including apprenticeship. The Contractor agrees to post in conspicuous places, available to employees and applicants for employment, notices to be provided setting forth the provisions of this nondiscrimination clause.

- (2) The Contractor will, in all solicitations or advertisements for employees placed by or on behalf of the Contractor, state that all qualified applicants will receive consideration for employment without regard to race, color, religion, sex, sexual orientation, gender identity, or national origin.
- (3) The Contractor will not discharge or in any other manner discriminate against any employee or applicant for employment because such employee or applicant has inquired about, discussed, or disclosed the compensation of the employee or applicant or another employee or applicant. This provision shall not apply to instances in which an employee who has access to the compensation information of other employees or applicants as a part of such employee's essential job functions discloses the compensation of such other employees or applicants to individuals who do not otherwise have access to such information, unless such disclosure is in response to a formal complaint or charge, in furtherance of an investigation, proceeding, hearing, or action, including an investigation conducted by the employer, or is consistent with the Contractor's legal duty to furnish information.
- (4) The Contractor will send to each labor union or representative of workers with which he has a collective bargaining agreement or other contract or understanding, a notice to be provided advising the said labor union or workers' representatives of the Contractor's commitments under this section, and shall post copies of the notice in conspicuous places available to employees and applicants for employment.
- (5) The Contractor will comply with all provisions of Executive Order 11246 of September 24, 1965, and of the rules, regulations, and relevant orders of the Secretary of Labor.
- (6) The Contractor will furnish all information and reports required by Executive Order 11246 of September 24, 1965, and by rules, regulations, and orders of the Secretary of Labor, or pursuant thereto, and will permit access to his books, records, and accounts by the administering agency and the Secretary of Labor for purposes of investigation to ascertain compliance with such rules, regulations, and orders.
- (7) In the event of the Contractor's noncompliance with the nondiscrimination clauses of this contract or with any of the said rules, regulations, or orders, this contract may be canceled, terminated, or suspended in whole or in part and the Contractor may be declared ineligible for further Government contracts or federally assisted construction contracts in accordance with procedures authorized in Executive Order 11246 of September 24, 1965, and such other sanctions may be imposed and remedies invoked as provided in



	<p>Executive Order 11246 of September 24, 1965, or by rule, regulation, or order of the Secretary of Labor, or as otherwise provided by law.</p> <p>(8) The Contractor will include the portion of the sentence immediately preceding paragraph (1) and the provisions of paragraphs (1) through (8) in every subcontract or purchase order unless exempted by rules, regulations, or orders of the Secretary of Labor issued pursuant to section 204 of Executive Order 11246 of September 24, 1965, so that such provisions will be binding upon each Subcontractor or vendor. The Contractor will take such action with respect to any subcontract or purchase order as the administering agency may direct as a means of enforcing such provisions, including sanctions for noncompliance:</p> <p>Provided, however, that in the event a Contractor becomes involved in, or is threatened with, litigation with a Subcontractor or vendor as a result of such direction by the administering agency, the Contractor may request the United States to enter into such litigation to protect the interests of the United States.</p> <p>The [recipient] further agrees that it will be bound by the above equal opportunity clause with respect to its own employment practices when it participates in federally assisted construction work: Provided, that if the [recipient] so participating is a State or local government, the above equal opportunity clause is not applicable to any agency, instrumentality or subdivision of such government which does not participate in work on or under the contract.</p> <p>The [recipient] agrees that it will assist and cooperate actively with the administering agency and the Secretary of Labor in obtaining the compliance of Contractors and Subcontractors with the equal opportunity clause and the rules, regulations, and relevant orders of the Secretary of Labor, that it will furnish the administering agency and the Secretary of Labor such information as they may require for the supervision of such compliance, and that it will otherwise assist the administering agency in the discharge of the agency's primary responsibility for securing compliance.</p> <p>The [recipient] further agrees that it will refrain from entering into any contract or contract modification subject to Executive Order 11246 of September 24, 1965, with a Contractor debarred from, or who has not demonstrated eligibility for, Government contracts and federally assisted construction contracts pursuant to the Executive Order and will carry out such sanctions and penalties for violation of the equal opportunity clause as may be imposed upon Contractors and Subcontractors by the administering agency or the Secretary of Labor pursuant to Part II, Subpart D of the Executive Order. In addition, the [recipient] agrees that if it fails or refuses to comply with these undertakings, the administering agency may take any or all of the following actions: Cancel, terminate, or suspend in whole or in part this grant (contract, loan, insurance, guarantee); refrain from extending any further assistance to the [recipient] under the program with respect to which the failure or refund occurred until satisfactory assurance of future compliance has been received from such [recipient]; and refer the case to the Department of Justice for appropriate legal proceedings.</p>	
>\$2,000	<p>Davis-Bacon Act, as amended (<a href="#">40 U.S.C. 3141-3148</a>). When required by Federal program legislation, all prime construction contracts in excess of \$2,000 awarded by non-Federal entities must include a provision for compliance with the Davis-Bacon Act (<a href="#">40 U.S.C. 3141-3144</a>, and <a href="#">3146-3148</a>) as supplemented by Department of Labor regulations (<a href="#">29 CFR Part 5</a>, "Labor Standards Provisions</p>	2 CFR 200 APPENDIX II (D)

	Applicable to Contracts Covering Federally Financed and Assisted Construction”). In accordance with the statute, Contractors must be required to pay wages to laborers and mechanics at a rate not less than the prevailing wages specified in a wage determination made by the Secretary of Labor. In addition, Contractors must be required to pay wages not less than once a week. The non-Federal entity must place a copy of the current prevailing wage determination issued by the Department of Labor in each solicitation. The decision to award a contract or subcontract must be conditioned upon the acceptance of the wage determination. The non-Federal entity must report all suspected or reported violations to the Federal awarding agency. The contracts must also include a provision for compliance with the Copeland “Anti-Kickback” Act ( <a href="#">40 U.S.C. 3145</a> ), as supplemented by Department of Labor regulations ( <a href="#">29 CFR Part 3</a> , “Contractors and Subcontractors on Public Building or Public Work Financed in Whole or in Part by Loans or Grants from the United States”). The Act provides that each Contractor or subrecipient must be prohibited from inducing, by any means, any person employed in the construction, completion, or repair of public work, to give up any part of the compensation to which he or she is otherwise entitled. The non-Federal entity must report all suspected or reported violations to the Federal awarding agency.	
>\$100,000	Contract Work Hours and Safety Standards Act ( <a href="#">40 U.S.C. 3701-3708</a> ). Where applicable, all contracts awarded by the non-Federal entity in excess of \$100,000 that involve the employment of mechanics or laborers must include a provision for compliance with <a href="#">40 U.S.C. 3702</a> and <a href="#">3704</a> , as supplemented by Department of Labor regulations ( <a href="#">29 CFR Part 5</a> ). Under <a href="#">40 U.S.C. 3702</a> of the Act, each Contractor must be required to compute the wages of every mechanic and laborer on the basis of a standard work week of 40 hours. Work in excess of the standard work week is permissible provided that the worker is compensated at a rate of not less than one and a half times the basic rate of pay for all hours worked in excess of 40 hours in the work week. The requirements of <a href="#">40 U.S.C. 3704</a> are applicable to construction work and provide that no laborer or mechanic must be required to work in surroundings or under working conditions which are unsanitary, hazardous or dangerous. These requirements do not apply to the purchases of supplies or materials or articles ordinarily available on the open market, or contracts for transportation or transmission of intelligence.	2 CFR 200 APPENDIX II (E)
None	Rights to Inventions Made Under a Contract or Agreement. If the Federal award meets the definition of “funding agreement” under <a href="#">37 CFR § 401.2 (a)</a> and the recipient or subrecipient wishes to enter into a contract with a small business firm or nonprofit organization regarding the substitution of parties, assignment or performance of experimental, developmental, or research work under that “funding agreement,” the recipient or subrecipient must comply with the requirements of <a href="#">37 CFR Part 401</a> , “Rights to Inventions Made by Nonprofit Organizations and Small Business Firms Under Government Grants, Contracts and Cooperative Agreements,” and any implementing regulations issued by the awarding agency.	2 CFR 200 APPENDIX II (F)
>\$150,000	Clean Air Act ( <a href="#">42 U.S.C. 7401-7671q.</a> ) and the Federal Water Pollution Control Act ( <a href="#">33 U.S.C. 1251-1387</a> ), as amended - Contracts and subgrants of amounts in excess of \$150,000 must contain a provision that requires the non-Federal award to agree to comply with all applicable standards, orders or regulations issued pursuant to the Clean Air Act ( <a href="#">42 U.S.C. 7401-7671q</a> ) and the Federal Water Pollution Control Act as amended ( <a href="#">33 U.S.C. 1251-1387</a> ). Violations must be reported to the Federal awarding agency and the Regional Office of the Environmental Protection Agency (EPA).	2 CFR 200 APPENDIX II (G)

>\$25,000	Debarment and Suspension (Executive Orders 12549 and 12689) - A contract award (see <a href="#">2 CFR 180.220</a> ) must not be made to parties listed on the governmentwide exclusions in the System for Award Management (SAM), in accordance with the OMB guidelines at <a href="#">2 CFR 180</a> that implement Executive Orders 12549 (3 CFR part 1986 Comp., p. 189) and 12689 (3 CFR part 1989 Comp., p. 235), "Debarment and Suspension." SAM Exclusions contains the names of parties debarred, suspended, or otherwise excluded by agencies, as well as parties declared ineligible under statutory or regulatory authority other than Executive Order 12549.	2 CFR 200 APPENDIX II (H)
>\$100,000	Byrd Anti-Lobbying Amendment ( <a href="#">31 U.S.C. 1352</a> ) - Contractors that apply or bid for an award exceeding \$100,000 must file the required certification. Each tier certifies to the tier above that it will not and has not used Federal appropriated funds to pay any person or organization for influencing or attempting to influence an officer or employee of any agency, a member of Congress, officer or employee of Congress, or an employee of a member of Congress in connection with obtaining any Federal contract, grant or any other award covered by <a href="#">31 U.S.C. 1352</a> . Each tier must also disclose any lobbying with non-Federal funds that takes place in connection with obtaining any Federal award. Such disclosures are forwarded from tier to tier up to the non-Federal award.	2 CFR 200 APPENDIX II (I) and 24 CFR §570.303
	See 2 CFR §200.323.	2 CFR 200 APPENDIX II (J)
	See 2 CFR §200.216.	2 CFR 200 APPENDIX II (K)
	See 2 CFR §200.322.	2 CFR 200 APPENDIX II (L)
>\$10,000	A non-Federal entity that is a state agency or agency of a political subdivision of a state and its Contractors must comply with section 6002 of the Solid Waste Disposal Act, as amended by the Resource Conservation and Recovery Act. The requirements of Section 6002 include procuring only items designated in guidelines of the Environmental Protection Agency (EPA) at <a href="#">40 CFR part 247</a> that contain the highest percentage of recovered materials practicable, consistent with maintaining a satisfactory level of competition, where the purchase price of the item exceeds \$10,000 or the value of the quantity acquired during the preceding fiscal year exceeded \$10,000; procuring solid waste management services in a manner that maximizes energy and resource recovery; and establishing an affirmative procurement program for procurement of recovered materials identified in the EPA guidelines.	2 CFR 200.323
>\$100,000	<p><i>§135.38 Section 3 clause</i>  <i>All section 3 covered contracts shall include the following clause (referred to as the section 3 clause):</i></p> <p>A. The work to be performed under this contract is subject to the requirements of section 3 of the Housing and Urban Development Act of 1968, as amended, 12 U.S.C. 1701u (Section 3). The purpose of section 3 is to ensure that employment and other economic opportunities generated by HUD assistance or HUD-assisted projects covered by section 3, shall, to the greatest extent feasible, be directed to low- and very low-income persons, particularly persons who are recipients of HUD assistance for housing.</p> <p>B. The parties to this contract agree to comply with HUD's regulations in 24 CFR part 135, which implement section 3. As evidenced by their execution of this contract, the parties to this contract certify that they are under no contractual or other impediment that would prevent them from complying with the part 135 regulations.</p>	

	<p>C. The Contractor agrees to send to each labor organization or representative of workers with which the Contractor has a collective bargaining agreement or other understanding, if any, a notice advising the labor organization or workers' representative of the Contractor's commitments under this section 3 clause, and will post copies of the notice in conspicuous places at the work site where both employees and applicants for training and employment positions can see the notice. The notice shall describe the section 3 preference, shall set forth minimum number and job titles subject to hire, availability of apprenticeship and training positions, the qualifications for each; and the name and location of the person(s) taking applications for each of the positions; and the anticipated date the work shall begin.</p> <p>D. The Contractor agrees to include this section 3 clause in every subcontract subject to compliance with regulations in 24 CFR part 135, and agrees to take appropriate action, as provided in an applicable provision of the subcontract or in this section 3 clause, upon a finding that the Subcontractor is in violation of the regulations in 24 CFR part 135. The Contractor will not subcontract with any Subcontractor where the Contractor has notice or knowledge that the Subcontractor has been found in violation of the regulations in 24 CFR part 135.</p> <p>E. The Contractor will certify that any vacant employment positions, including training positions, that are filled (1) after the Contractor is selected but before the contract is executed, and (2) with persons other than those to whom the regulations of 24 CFR part 135 require employment opportunities to be directed, were not filled to circumvent the Contractor's obligations under 24 CFR part 135.</p> <p>F. Noncompliance with HUD's regulations in 24 CFR part 135 may result in sanctions, termination of this contract for default, and debarment or suspension from future HUD assisted contracts.</p> <p>G. With respect to work performed in connection with section 3 covered Indian housing assistance, section 7(b) of the Indian Self-Determination and Education Assistance Act (25 U.S.C. 450e) also applies to the work to be performed under this contract. Section 7(b) requires that to the greatest extent feasible (i) preference and opportunities for training and employment shall be given to Indians, and (ii) preference in the award of contracts and subcontracts shall be given to Indian organizations and Indian-owned Economic Enterprises. Parties to this contract that are subject to the provisions of section 3 and section 7(b) agree to comply with section 3 to the maximum extent feasible, but not in derogation of compliance with section 7(b).</p>	
None	<p>Section 889(b)(1) of the John S. McCain National Defense Authorization Act for Fiscal Year 2019 (FY2019 NDAA) and 2 C.F.R. § 200.216, as implemented by FEMA Policy 405-143-1, Prohibitions on Expending FEMA Award Funds for Covered Telecommunications Equipment or Services (Interim), prohibit the obligation or expending of federal award funds on certain telecommunication products or from certain entities for national security reasons. Effective August 13, 2020, FEMA recipients and subrecipients, as well as their Contractors and Subcontractors, may not obligate or expend any FEMA award funds to:</p> <p>Recipients and subrecipients are prohibited from obligating or expending loan or grant funds to:</p> <ol style="list-style-type: none"> <li>(1) Procure or obtain;</li> <li>(2) Extend or renew a contract to procure or obtain; or</li> <li>(3) Enter into a contract (or extend or renew a contract) to procure or obtain equipment, services, or systems that uses covered</li> </ol>	2 CFR 200.216

	<p>telecommunications equipment or services as a substantial or essential component of any system, or as critical technology as part of any system. As described in <a href="#">Public Law 115-232</a>, section 889, covered telecommunications equipment is telecommunications equipment produced by Huawei Technologies Company or ZTE Corporation (or any subsidiary or affiliate of such entities).</p> <p>(i) For the purpose of public safety, security of government facilities, physical security surveillance of critical infrastructure, and other national security purposes, video surveillance and telecommunications equipment produced by Hytera Communications Corporation, Hangzhou Hikvision Digital Technology Company, or Dahua Technology Company (or any subsidiary or affiliate of such entities).</p> <p>(ii) Telecommunications or video surveillance services provided by such entities or using such equipment.</p> <p>(iii) Telecommunications or video surveillance equipment or services produced or provided by an entity that the Secretary of Defense, in consultation with the Director of the National Intelligence or the Director of the Federal Bureau of Investigation, reasonably believes to be an entity owned or controlled by, or otherwise connected to, the government of a covered foreign country.</p> <p>(b) In implementing the prohibition under <a href="#">Public Law 115-232</a>, section 889, subsection (f), paragraph (1), heads of executive agencies administering loan, grant, or subsidy programs shall prioritize available funding and technical support to assist affected businesses, institutions and organizations as is reasonably necessary for those affected entities to transition from covered communications equipment and services, to procure replacement equipment and services, and to ensure that communications service to users and customers is sustained.</p> <p>(c) See <a href="#">Public Law 115-232</a>, section 889 for additional information.</p> <p>(d) See also <a href="#">§ 200.471</a>.</p>	
None	<p>As appropriate and to the extent consistent with law, the non-Federal entity should, to the greatest extent practicable under a Federal award, provide a preference for the purchase, acquisition, or use of goods, products, or materials produced in the United States (including but not limited to iron, aluminum, steel, cement, and other manufactured products). The requirements of this section must be included in all subawards including all contracts and purchase orders for work or products under this award. For purposes of this section:</p> <p>(1) "Produced in the United States" means, for iron and steel products, that all manufacturing processes, from the initial melting stage through the application of coatings, occurred in the United States.</p> <p>(2) "Manufactured products" means items and construction materials composed in whole or in part of non-ferrous metals such as aluminum; plastics and polymer-based products such as polyvinyl chloride pipe; aggregates such as concrete; glass, including optical fiber; and lumber.</p>	2 CFR 200.322(a)(b)(1) (2)
None	<p>The Federal awarding agency must establish conflict of interest policies for Federal awards. The non-Federal entity must disclose in writing any potential conflict of interest to the Federal awarding agency or pass-through entity in accordance with applicable Federal awarding agency policy.</p>	2 CFR 200.112

None	<p>The Federal awarding agency and the non-Federal entity should, whenever practicable, collect, transmit, and store Federal award-related information in open and machine-readable formats rather than in closed formats or on paper in accordance with applicable legislative requirements. A machine-readable format is a format in a standard computer language (not English text) that can be read automatically by a web browser or computer system. The Federal awarding agency or pass-through entity must always provide or accept paper versions of Federal award-related information to and from the non-Federal entity upon request. If paper copies are submitted, the Federal awarding agency or pass-through entity must not require more than an original and two copies. When original records are electronic and cannot be altered, there is no need to create and retain paper copies. When original records are paper, electronic versions may be substituted through the use of duplication or other forms of electronic media provided that they are subject to periodic quality control reviews, provide reasonable safeguards against alteration, and remain readable.</p>	2 CFR 200.336
None	<p>Contracting with HUB, small and minority businesses, women's business enterprises, and labor surplus area firms.</p> <p>(a) The non-Federal entity must take all necessary affirmative steps to assure that minority businesses, women's business enterprises, and labor surplus area firms are used when possible.</p> <p>(b) Affirmative steps must include:</p> <p>(1) Placing qualified small and minority businesses and women's business enterprises on solicitation lists;</p> <p>(2) Assuring that small and minority businesses, and women's business enterprises are solicited whenever they are potential sources;</p> <p>(3) Dividing total requirements, when economically feasible, into smaller tasks or quantities to permit maximum participation by small and minority businesses, and women's business enterprises;</p> <p>(4) Establishing delivery schedules, where the requirement permits, which encourage participation by small and minority businesses, and women's business enterprises;</p> <p>(5) Using the services and assistance, as appropriate, of such organizations as the Small Business Administration and the Minority Business Development Agency of the Department of Commerce; and</p> <p>(6) Requiring the prime Contractor, if subcontracts are to be let, to take the affirmative steps listed in paragraphs (b)(1) through (5) of this section.</p>	2 CFR 200.321
None	<p>Financial records, supporting documents, statistical records, and all other non-Federal entity records pertinent to a Federal award must be retained for a period of three years from the date of submission of the final expenditure report or, for Federal awards that are renewed quarterly or annually, from the date of the submission of the quarterly or annual financial report, respectively, as reported to the Federal awarding agency or pass-through entity in the case of a subrecipient. Federal awarding agencies and pass-through entities must not impose any other record retention requirements upon non-Federal entities. The only exceptions are the following:</p> <p>(a) If any litigation, claim, or audit is started before the expiration of the 3-year period, the records must be retained until all litigation, claims, or audit findings involving the records have been resolved and final action taken.</p> <p>(b) When the non-Federal entity is notified in writing by the Federal awarding agency, cognizant agency for audit, oversight agency for audit, cognizant agency for indirect costs, or pass-through entity to extend the retention period.</p> <p>(c) Records for real property and equipment acquired with Federal funds must be retained for 3 years after final disposition.</p>	2 CFR 200.334

	<p>(d) When records are transferred to or maintained by the Federal awarding agency or pass-through entity, the 3-year retention requirement is not applicable to the non-Federal entity.</p> <p>(e) Records for program income transactions after the period of performance. In some cases, recipients must report program income after the period of performance. Where there is such a requirement, the retention period for the records pertaining to the earning of the program income starts from the end of the non-Federal entity's fiscal year in which the program income is earned.</p> <p>(f) Indirect cost rate proposals and cost allocations plans. This paragraph applies to the following types of documents and their supporting records: Indirect cost rate computations or proposals, cost allocation plans, and any similar accounting computations of the rate at which a particular group of costs is chargeable (such as computer usage chargeback rates or composite fringe benefit rates).</p> <p>(1) <i>If submitted for negotiation.</i> If the proposal, plan, or other computation is required to be submitted to the Federal Government (or to the pass-through entity) to form the basis for negotiation of the rate, then the 3-year retention period for its supporting records starts from the date of such submission.</p> <p>(2) <i>If not submitted for negotiation.</i> If the proposal, plan, or other computation is not required to be submitted to the Federal Government (or to the pass-through entity) for negotiation purposes, then the 3-year retention period for the proposal, plan, or computation and its supporting records starts from the end of the fiscal year (or other accounting period) covered by the proposal, plan, or other computation.</p>	
None	<p>CONTRACTS WITH COMPANIES ENGAGED IN BUSINESS WITH IRAN, SUDAN, OR FOREIGN TERRORIST ORGANIZATION PROHIBITED. A governmental entity may not enter into a governmental contract with a company that is identified on a list prepared and maintained under Section 2270.0052, 2270.0102, or 2270.0152. In accordance with Texas Government Code, Chapter 2252, Subchapter F, <b>Respondent</b> hereby represents and warrants that it is not a company identified on the lists prepared and maintained under Texas Government Code §§ 2270.0052 (companies with business operations in Sudan), 2270.0102 (companies with business operations in Iran), or 2270.0152 (companies known to have contracts with or provide supplies or services to a foreign terrorist organization). Notwithstanding the foregoing, a company that the United States government affirmatively declares to be excluded from its federal sanctions regime relating to Sudan, Iran, or to a foreign terrorist organization, is not subject to contract prohibition under this clause. A company claiming such exemption must submit the official copy of the declaration.</p>	Texas Government Code 2252.152
>\$100,000	<p>PROVISION REQUIRED IN CONTRACT. (a) This section applies only to certain solicitations and contracts. Section 2271.002 of the Texas Government Code states the following:</p> <p>(a) This section applies only to a contract that:</p> <p>(1) is between a governmental entity and a company with 10 or more full-time employees; and</p> <p>(2) has a value of \$100,000 or more that is to be paid wholly or partly from public funds of the governmental entity.</p> <p>(b) A governmental entity may not enter into a contract with a company for goods or services unless the contract contains a written verification from the company that it:</p>	Texas Government Code 2271.002

	(1) does not boycott Israel; and (2) will not boycott Israel during the term of the contract. Section 2271.001(2) of the Government Code defines "company" to be the meaning assigned by Section 808.001 of the Texas Government Code, except that the term does not include a sole proprietorship.	
Option Contract Language for contracts awarded prior to Grant Award	The contract award is contingent upon the receipt of federal funds. If no such funds are awarded, the contract shall terminate.	Optional
	Mandatory standards and policies relating to energy efficiency which are contained in the state energy conservation plan issued in compliance with the Energy Policy and Conservation Act.	42 U.S.C. 6201
	The Firm agrees that no otherwise qualified individual with disabilities shall, solely by reason of his/her disability, be denied the benefits of, or be subjected to discrimination, including discrimination in employment, under any program or activity receiving federal financial assistance.	Section 504 of the Rehabilitation Act of 1973, as amended.



## BYRD ANTI-LOBBYING CERTIFICATION

---

Certification for Contracts, Grants, Loans, and Cooperative Agreements-The undersigned certifies, to the best of his or her knowledge and belief, that:

- 1) No Federal appropriated funds have been paid or will be paid, by or on behalf of the undersigned, to any person for influencing or attempting to influence an officer or employee of an agency, a Member of Congress, an officer or employee of Congress, or an employee of a Member of Congress in connection with the awarding of any Federal contract, the making of any Federal grant, the making of any Federal loan, the entering into of any cooperative agreement, and the extension, continuation, renewal, amendment, or modification of any Federal contract, grant, loan, or cooperative agreement.
- 2) If any funds other than Federal appropriated funds have been paid or will be paid to any person for influencing or attempting to influence an officer or employee of any agency, a Member of Congress, an officer or employee of Congress, or an employee of a Member of Congress in connection with this Federal contract, grant, loan, or cooperative agreement, the undersigned shall complete and submit Standard Form-LLL, "Disclosure Form to Report Lobbying," in accordance with its instructions.
- 3) The undersigned shall require that the language of this certification be included in the award documents for all subawards at all tiers (including subcontracts, subgrants, and contracts under grants, loans, and cooperative agreements) and that all subrecipients shall certify and disclose accordingly.

This certification is a material representation of fact upon which reliance was placed when this transaction was made or entered into. Submission of this certification is a prerequisite for making or entering into this transaction imposed by section 1352, title 31, U.S. Code. Any person who fails to file the required certification shall be subject to a civil penalty of not less than \$10,000 and not more than \$100,000 for each such failure.

The Contractor \_\_\_\_\_ certifies or affirms the truthfulness and accuracy of each statement of its certification and disclosure, if any. In addition, the Contractor understands and agrees that the provisions of 31 U.S.C.Chap. 38, Administrative Remedies for False Claims and Statements, apply to this certification and disclosure, if any.

\_\_\_\_\_  
**Signature of Contractor's Authorized Official**

\_\_\_\_\_  
**Name and Title of Contractor's Authorized Official**

\_\_\_\_\_  
**Date**

<p><b>REQUIRED FORM</b> <b><u>Bidder</u>: Please complete this form and include with bid submission.</b></p>
--

## DEBARMENT/SUSPENSION CERTIFICATION

---

Non-Federal entities and Contractors are subject to the debarment and suspension regulations implementing Executive Order 12549, Debarment and Suspension (1986) and Executive Order 12689, Debarment and Suspension (1989) at 2 C.F.R. Part 180 and the Department of Homeland Security's regulations at 2 C.F.R. Part 3000 (No procurement Debarment and Suspension).

This requirement applies to all FEMA grant and cooperative agreement programs.

Federal Executive Order (E .O.) 12549 "Debarment" requires that all Contractors receiving individual awards, using federal funds, and all sub recipients certify that the organization and its principals are not debarred, suspended, proposed for debarment, declared ineligible, or voluntarily excluded by any Federal department or agency from doing business with the Federal Government. By signing this document, you certify that your organization and its principals are not debarred. Failure to comply or attempts to edit this language may disqualify your bid. Information on debarment is available at the following websites: [www.sam.gov](http://www.sam.gov) and <https://acquisition.gov/far/index.html> see section 52.209-6.

The Contractor \_\_\_\_\_ certifies or affirms by your signature that neither you nor your principal is presently debarred, suspended, proposed for debarment, declared ineligible, or voluntarily excluded from participation in this transaction by any federal department or agency.

\_\_\_\_\_  
**Signature of Contractor's Authorized Official**

\_\_\_\_\_  
**Name and Title of Contractor's Authorized Official**

\_\_\_\_\_  
**Date**

<p><b>REQUIRED FORM</b> <b><u>Bidder</u>: Please complete this form and include with bid submission.</b></p>
--

## CIVIL RIGHTS COMPLIANCE PROVISIONS

---

### **1. EQUAL EMPLOYMENT OPPORTUNITY (Equal Opportunity Clause)**

(For all awarded contracts that meet the definition of "federally assisted construction contract" provided in 41 CFR Part 60-1.3)

During the performance of this contract, the Contractor agrees as follows:

- 1) The Contractor will not discriminate against any employee or applicant for employment because of race, color, religion, sex, sexual orientation, gender identity, or national origin. The Contractor will take affirmative action to ensure that applicants are employed, and that employees are treated during employment without regard to their race, color, religion, sex, sexual orientation, gender identity, or national origin. Such action shall include, but not be limited to the following:  
Employment, upgrading, demotion, or transfer; recruitment or recruitment advertising; layoff or termination; rates of pay or other forms of compensation; and selection for training, including apprenticeship. The Contractor agrees to post in conspicuous places, available to employees and applicants for employment, notices to be provided setting forth the provisions of this nondiscrimination clause.
- 2) The Contractor will, in all solicitations or advertisements for employees placed by or on behalf of the Contractor, state that all qualified applicants will receive consideration for employment without regard to race, color, religion, sex, sexual orientation, gender identity, or national origin.
- 3) The Contractor will not discharge or in any other manner discriminate against any employee or applicant for employment because such employee or applicant has inquired about, discussed, or disclosed the compensation of the employee or applicant or another employee or applicant. This provision shall not apply to instances in which an employee who has access to the compensation information of other employees or applicants as a part of such employee's essential job functions discloses the compensation of such other employees or applicants to individuals who do not otherwise have access to such information, unless such disclosure is in response to a formal complaint or charge, in furtherance of an investigation, proceeding, hearing, or action, including an investigation conducted by the employer, or is consistent with the Contractor's legal duty to furnish information.
- 4) The Contractor will send to each labor union or representative of workers with which he has a collective bargaining agreement or other contract or understanding, a notice to be provided advising the said labor union or workers' representatives of the Contractor's commitments under this section and shall post copies of the notice in conspicuous places available to employees and applicants for employment.
- 5) The Contractor will comply with all provisions of Executive Order 11246 of September 24, 1965, and of the rules, regulations, and relevant orders of the Secretary of Labor.
- 6) The Contractor will furnish all information and reports required by Executive Order 11246 of September 24, 1965, and by rules, regulations, and orders of the Secretary of Labor, or pursuant thereto, and will permit access to his books, records, and accounts by the administering agency and the Secretary of Labor for purposes of investigation to ascertain compliance with such rules, regulations, and orders.
- 7) In the event of the Contractor's noncompliance with the nondiscrimination clauses of this contract or with any of the said rules, regulations, or order this contract may be canceled, terminated, or suspended in whole or in part and the Contractor may be declared ineligible for further Government contracts or federally assisted construction contracts in accordance with procedures authorized in Executive Order 11246 of September 24, 1965, and such other sanctions may be imposed and remedies invoked as provided in Executive Order 11246 of September 24, 1965, or by rule, regulation, or order of the Secretary of Labor, or as otherwise provided by law.
- 8) The Contractor will include the portion of the sentence immediately preceding paragraph (1) and the provisions of paragraphs (1) through (8) in every subcontract or purchase order unless exempted by rules, regulations, or orders of the Secretary of Labor issued pursuant to section 204 of Executive Order 11246 of September 24, 1965, so that such provisions will be binding upon each Subcontractor or vendor. The Contractor will take such action with respect to any subcontract or purchase order as the administering agency may direct as a means of enforcing such provisions, including sanctions for noncompliance:

**CIVIL RIGHTS COMPLIANCE PROVISIONS (CONTINUED)**

---

Provided, however, that in the event a Contractor becomes involved in, or is threatened with, litigation with a Subcontractor or vendor as a result of such direction by the administering agency, the Contractor may request the United States to enter into such litigation to protect the interests of the United States.

The applicant further agrees that it will be bound by the above equal opportunity clause with respect to its own employment practices when it participates in federally assisted construction work: Provided, that if the applicant so participating is a State or local government, the above equal opportunity clause is not applicable to any agency, instrumentality or subdivision of such government which does not participate in work on or under the contract.

The applicant agrees that it will assist and cooperate actively with the administering agency and the Secretary of Labor in obtaining the compliance of Contractors and Subcontractors with the equal opportunity clause and the rules, regulations, and relevant orders of the Secretary of Labor, that it will furnish the administering agency and the Secretary of Labor such information as they may require for the supervision of such compliance, and that it will otherwise assist the administering agency in the discharge of the agency's primary responsibility for securing compliance.

The applicant further agrees that it will refrain from entering into any contract or contract modification subject to Executive Order 11246 of September 24, 1965, with a Contractor debarred from, or who has not demonstrated eligibility for, Government contracts and federally assisted construction contracts pursuant to the Executive Order and will carry out such sanctions and penalties for violation of the equal opportunity clause as may be imposed upon Contractors and Subcontractors by the administering agency or the Secretary of Labor pursuant to Part II, Subpart D of the Executive Order. In addition, the applicant agrees that if it fails or refuses to comply with these undertakings, the administering agency may take any or all of the following actions: Cancel, terminate, or suspend in whole or in part this grant (contract, loan, insurance, guarantee); refrain from extending any further assistance to the applicant under the program with respect to which the failure or refund occurred until satisfactory assurance of future compliance has been received from such applicant; and refer the case to the Department of Justice for appropriate legal proceedings.

\_\_\_\_\_  
**Signature of Contractor's Authorized Official**

\_\_\_\_\_  
**Name and Title of Contractor's Authorized Official**

\_\_\_\_\_  
**Date**

<p><b>REQUIRED FORM</b> <b><u>Bidder:</u> Please complete this form and include with bid submission.</b></p>
--

### SECTION 3: SPECIAL REQUIREMENTS/BID SUBMISSION INSTRUCTIONS

---

The following requirements and instructions supersede General Requirements where applicable.

#### 1. SUBMISSION OF BID.

Bidder is Responsible for Submitting:

One (1) Original and two (2) Bid Copies; with all copies to include a Completed Copy of this Specifications Packet (including technical specifications), **in its entirety**.

The County requests that bid submissions NOT be bound by staples or glued spines.

Each Bidder shall ensure that required parts of their bid submission are completed with accuracy and submitted as per the requirements within this specifications packet, including any addenda.

Additionally, Bidder shall monitor the Jefferson County Purchasing Department Website for any addenda, additional instructions, or bid updates. <https://www.co.jefferson.tx.us/Purchasing/>

**Failure to return and/or complete all required documentation will result in a response being declared as non-responsive.**

**Bids must be submitted in complete original form by mail or messenger to the following address:**

Jefferson County Purchasing Department  
1149 Pearl Street, 1<sup>st</sup> Floor  
Beaumont, TX 77701

**BID PACKAGING:** Bidder shall submit response in a tightly sealed opaque envelope or box, plainly marked "SEALED BID." The outside of the envelope or box shall also include the IFB Number, IFB Name, IFB Due Date, and the Bidder's Name and Address; and shall be addressed to the Purchasing Agent.

**All submissions must be received by 11:00 am CT, Wednesday, November 13, 2024.**

Bids will be accepted at the above address until the time and date specified herein, and immediately after will be publicly opened and read aloud.

Jefferson County will not accept any responsibility for bids being delivered by third party carriers.

Late bids will not be accepted and will be returned unopened to the Bidder.

Jefferson County shall not be responsible for any effort or cost expended in the preparation of a response to this IFB.

All bid responses submitted in response to this invitation shall become the property of Jefferson County and will be a matter of public record available for review.

All protests should be coordinated through the Purchasing Office prior to award recommendation to Commissioners' Court.

**COURTHOUSE SECURITY:** All visitors to the Courthouse must pass through Security. Respondents planning to hand deliver proposals must allow time to get through Security, as a delay in entering the Courthouse will not be accepted as an excuse for late submittal. Mondays and Tuesdays are particularly heavy days.

In response to the Covid-19 pandemic, Jefferson County has implemented precautionary measures as currently recommended by the CDC within its facilities. Bidders are strongly urged to plan accordingly.

**COUNTY HOLIDAYS (2024):**

January 15	(Monday)	Martin Luther King, Jr. Day
March 29	(Friday)	Good Friday
May 27	(Monday)	Memorial Day
June 19	(Wednesday)	Juneteenth
July 4	(Thursday)	Independence Day
September 2	(Monday)	Labor Day
November 11	(Monday)	Veteran's Day
November 28 & 29	(Thursday & Friday)	Thanksgiving
December 25 & 26	(Wednesday & Thursday)	Christmas
January 1, 2025	(Wednesday)	New Year's

**Submissions During Time of Inclement Weather, Disaster, or Emergency:**

In case of inclement weather or any other unforeseen event causing the County to close for business on the date of a bid/proposal/statement of qualifications submission deadline, the IFB closing will automatically be postponed until the next business day that County offices are open to the public. Should inclement weather conditions or any other unforeseen event cause delays in courier service operations, the County may issue an addendum to all known vendors interested in the project to extend the deadline. It will be the responsibility of the vendor to notify the county of their interest in the project should these conditions impact their ability to submit a bid/proposal/statement of qualifications submission before the stated deadline. The County reserves the right to make the final judgement call to extend any deadline.

Should an emergency or unanticipated event interrupt normal County processes, and bid/proposal/statement of qualifications submissions cannot be received by the Jefferson County Purchasing Department’s office by the exact time specified in the IFB and urgent County requirements preclude amendment to the IFB, the time specified for receipt of Statements of Qualifications will be deemed to be extended to the same time of day specified in the solicitation on the first business day on which normal County processes resume.

**2. PRE-BID MEETING AND WALK-THROUGH.**

Due to the nature of this Bid, a Pre-Bid Conference will not be held for this project.

**3. QUESTIONS/DEADLINE FOR QUESTIONS.**

Questions may be emailed to **Mistey Reeves, Assistant Purchasing Agent** at: [mistey.reeves@jeffcotx.us](mailto:mistey.reeves@jeffcotx.us). If no response in 72 hours, contact **Deborah Clark, Purchasing Agent** at: [deb.clark@jeffcotx.us](mailto:deb.clark@jeffcotx.us). The Deadline for asking questions or requesting additional information (in writing) is 5:00 pm, CT, Tuesday, November 5, 2024 at 5:00 pm.

**4. VENDOR REGISTRATION (System for Award Management).**

Vendors doing business with Jefferson County are **required** to be registered with The System for Award Management (SAM), with an “active” status. The System for Award Management (SAM) is the Official U.S. Government system that consolidated the capabilities of CCR/FedReg, ORCA, and EPLS. There is NO fee to register for this site. Entities may register at no cost directly from the SAM website at: <https://www.sam.gov>

**In instances where a vendor has either an “Inactive” SAM Registration or is not currently registered with the System for Award Management, the Purchasing Department may *initially* accept proof (printout from the SAM website) that the vendor has begun the registration process in order for the IFB/RFQ/RFP submission to be considered as “responsive” to the specifications for the project.**

**However, the SAM Registration must be completed (showing “active” status, with no exclusions) prior to the award and/or execution of an agreement or contract for the project.**

**BIDDER: INSERT PROOF OF SYSTEM FOR AWARD MANAGEMENT (SAM) BEHIND THIS PAGE.**

## 5. FORM 1295 (Texas Ethics Commission) SUBMISSION REQUIREMENT/INSTRUCTIONS FOR BIDDERS.

All Non-Exempt Bidders are required to submit a completed FORM 1295 with bid submission.

### 1. Submit a FORM 1295 online via the Texas Ethics Commission website link below.

*Vendors must enter the required information on Form 1295, and print a copy of the completed form. The form will include a certification of filing that will contain a unique certification number.*

### 2. Submit a FORM 1295 **hard copy** (completed & signed by an Authorized Agent of the Awarded Vendor), to the Jefferson County Purchasing Department **with bid submission.**

FORM 1295, Completion Instructions, and Login Instructions are available via the Texas Ethics Commission Website at: [https://www.ethics.state.tx.us/whatsnew/elf\\_info\\_form1295.htm](https://www.ethics.state.tx.us/whatsnew/elf_info_form1295.htm)

A sample of a completed FORM 1295 is included on **PAGE 32**.

#### FORM 1295 Implementation Background:

In accordance with House Bill 1295 (passed January 1, 2016), Vendors entering into contracts and professional agreements with Jefferson County will be required to complete a Certificate of Interested Parties (FORM 1295), **unless contract is considered exempt as described below.**

In 2017, the Texas legislature amended the law to require Form 1295 to include an “unsworn declaration” which includes, among other things, the date of birth and address of the authorized representative signing the form. The unsworn declaration, including the date of birth and address of the signatory, replaces the notary requirement that applied to contracts entered into before January 1, 2018. The TEC filing application does not capture the date of birth or street address of the signatory and it will not appear on forms that are filed using the TEC filing application.

Changes to the law requiring certain businesses to file a Form 1295 are in effect for contracts entered into or amended on or after January 1, 2018. The changes exempt businesses from filing a Form 1295 for certain types of contracts and replace the need for a completed Form 1295 to be notarized. Instead, the person filing a 1295 needs to complete an “unsworn declaration.”

**Question:** Will the date of birth and address provided appear on the TEC’s website when the form is filed?

**Answer:** No. The TEC filing application does not capture the date of birth or street address of the signatory and it will not appear on forms that are filed using the TEC filing application. Although the TEC does not capture the date of birth and street address of the signatory, the contracting state agency or governmental agency will have a physical copy of the form that includes the date of birth and address of the signatory. The TEC cannot answer whether the contracting state agency or governmental agency may release such information. Questions regarding the Texas Public Information Act may be directed to the Office of the Attorney General. See also Paxton v. City of Dall., No. 03-13-00546-CV, 2015 Tex. App. LEXIS 5228, at \*10-11 (App.—Austin May 22, 2015) (mem. op.) (pet. denied) (available here)

#### **FORM 1295 EXEMPTIONS:**

**What type of contracts are exempt from the Form 1295 filing requirement under the amended law?**

The amended law adds to the list of types of contract exempt from the Form 1295 filing requirement.

**A completed Form 1295 is not required for:**

- a sponsored research contract of an institution of higher education
- an interagency contract of a state agency or an institution of higher education
- a contract related to health and human services if: the value of the contract cannot be determined at the time the contract is executed; and any qualified vendor is eligible for the contract
- a contract with a publicly traded business entity, including a wholly owned subsidiary of the business entity
- a contract with an electric utility, as that term is defined by Section 31.002, Utilities Code
- a contract with a gas utility, as that term is defined by Section 121.001, Utilities Code



**SAMPLE COMPLETED FORM 1295**

**VENDOR: FORM 1295 MUST BE COMPLETED/SUBMITTED ON TEXAS ETHICS COMMISSION WEBSITE. HARD COPY OF FORM 1295 IS TO BE PRINTED, COMPLETED, SIGNED, AND SUBMITTED WITH BID/PROPOSAL/AGREEMENT/CONTRACT. JEFFERSON COUNTY WILL CONFIRM RECEIPT OF COMPLETED HARD COPY WITH THE TEXAS ETHICS COMMISSION.**

**CERTIFICATE OF INTERESTED PARTIES**

**FORM 1295**

Complete Nos. 1 - 4 and 6 if there are interested parties. Complete Nos. 1, 2, 3, 5, and 6 if there are no interested parties.	<b>OFFICE USE ONLY</b>
<b>1</b> Name of business entity filing form, and the city, state and country of the business entity's place of business.  <b>VENDOR: ENTER YOUR BUSINESS NAME, CITY, STATE, AND COUNTRY HERE</b>	Must file online at <a href="http://www.ethics.state.tx.us/File">www.ethics.state.tx.us/File</a>
<b>2</b> Name of governmental entity or state agency that is a party to the contract for which the form is being filed.  <b>JEFFERSON COUNTY, TEXAS</b>	

**3** Provide the identification number used by the governmental entity or state agency to track or identify the contract, and provide a description of the services, goods, or other property to be provided under the contract.  
  
**VENDOR: ENTER BID/PROPOSAL/CONTRACT/AGREEMENT REF# AND TITLE HERE**

4 Name of Interested Party	City, State, Country (place of business)	Nature of Interest (check applicable)	
		Controlling	Intermediary
<b>VENDOR: ENTER EACH PERSON HAVING INTEREST, OWNERS ARE THE CONTROLLING PARTIES.</b>		X	
<b>VENDOR: WORKERS (OR NON-OWNERS) IN YOUR COMPANY ARE INTERMEDIARY PARTIES.</b>			X

**5** Check only if there is NO Interested Party. **CHECK BELOW IF APPLICABLE**

**6 UNSWORN DECLARATION VENDOR: COMPLETE, DATE, AND SIGN THIS DECLARATION SECTION.**

My name is \_\_\_\_\_, and my date of birth is \_\_\_\_\_.

My address is \_\_\_\_\_ (street) \_\_\_\_\_ (city) \_\_\_\_\_ (state) \_\_\_\_\_ (zip code) \_\_\_\_\_ (country).

I declare under penalty of perjury that the foregoing is true and correct.

Executed in \_\_\_\_\_ County, State of \_\_\_\_\_, on the \_\_\_\_\_ day of \_\_\_\_\_, 20\_\_\_\_.

\_\_\_\_\_  
Signature of authorized agent of contracting business entity  
(Declarant)

**ADD ADDITIONAL PAGES AS NECESSARY**

Form provided by Texas Ethics Commission [www.ethics.state.tx.us](http://www.ethics.state.tx.us) Revised 12/22/2017  
**NOTE: JEFFERSON COUNTY WILL KEEP A COPY OF THIS FORM ON FILE FOR EACH BID/PROPOSAL/CONTRACT/AGREEMENT AND EACH VENDOR RESPONDING TO BIDS/PROPOSALS.**

**BIDDER: INSERT COMPLETED FORM 1295 BEHIND THIS PAGE.**

**SECTION 3: SPECIAL REQUIREMENTS/BID SUBMISSION INSTRUCTIONS (CONTINUED)**

---

**6. MULTIPLE VENDOR AWARD.**

Jefferson County reserves the right to award this contract to more than one vendor at the County’s discretion.

**7. DELIVERY.**

If delivery is required, all items must be packaged so as to be protected from damage during shipping and handling. Any item(s) damaged in shipping must be replaced in kind, or repaired, by the Contractor, at the discretion of, and at no additional charge to, Jefferson County.

**8. PAYMENT.**

Jefferson County will pay original invoices that clearly itemize the goods and/or services provided as to quantity, part number, description, price, applicable discount (if any), labor charges showing time differential, if applicable and if previously agreed to, and delivery, installation, and set-up costs, if applicable and if previously agreed to. Only charges as stated on the Bid Form(s) submitted as a part of the bid will be considered.

Invoices must indicate Jefferson County as applicable, the address to which the product(s) and/or service(s) were delivered, and the applicable purchase order number. Invoices will be matched to delivery tickets prior to payment; therefore, all delivery tickets should have an accurate description of the product(s) and/or service(s).

**Invoices shall be submitted to:**

Jefferson County Auditing Department  
Attention: Accounts Payable  
1149 Pearl Street, 7<sup>th</sup> floor  
Beaumont, TX 77701.

**9. USAGE REPORTS.**

Jefferson County reserves the right to request, and receive at no additional cost, up to two (2) times during the contract period, a usage report detailing the products and/or services furnished to date under a contract resulting from this IFB. The reports must be furnished no later than five (5) working days after written request and itemize all purchases to date by Jefferson County department, description of each item purchased, including manufacturer, quantity of each item purchased, per unit and extended price of each item purchased, and total amount and price of all items purchased.

**10. INSURANCE.**

The Contractor (including any and all Subcontractors as defined in Section 11.1.3 below) shall, at all times during the term of this contract, maintain insurance coverages with not less than the type and requirements shown below. Such insurance is to be provided at the sole cost of the Contractor. These requirements do not establish limits of the Contractor’s liability.

All policies of insurance shall waive all rights of subrogation against the County, its officers, employees and agents; a copy of the policy wording or endorsement is required.

Contractor shall furnish Jefferson County with Certificate of Insurance naming Jefferson County as additional insured and will provide the actual policy wording or endorsement showing as such.

All insurance must be written by an insurer licensed to conduct business in the State of Texas.

**Minimum Insurance Requirements:**

<b>Public Liability, including Products &amp; Completed Operations</b>	\$1,000,000
<b>Excess Liability</b>	\$1,000,000

**Property Insurance (policy below that is applicable to this project):**

Improvements & Betterments Policy: Improvements/Remodeling (for Lease Tenants)

Builder's Risk Policy: Structural Coverage for Construction Projects

Installation Floater Policy: Improvements/Alterations to Existing Structure

**Workers' Compensation**

Statutory Coverage (See Section 9 Below)

**11. WORKERS' COMPENSATION INSURANCE**

11.1 Definitions:

11.1.1 **Certificate of coverage ("Certificate")** – A copy of a certificate of insurance, a certificate of authority to self-insure issued by the commission, or a coverage agreement, DWC-81, DWC-82, DWC-83, or DWC-84 showing statutory workers' compensation insurance coverage for the person's or entity's employees providing services on a project, for the duration of the project.

11.1.2 **Duration of the project** – Includes the time from the beginning of the work on the project until the Contractor's/person's work on the project has been completed and accepted by the governmental entity.

11.1.3 **Persons providing services on the project ("Subcontractor") in article 406.096** – Includes all persons or entities performing all or part of the services under the Contractor has undertaken to perform on the project, regardless of whether that person contracted directly with the Contractor and regardless of whether that person has employees. This includes, without limitation, independent Contractors, Subcontractor, leasing companies, motor carriers, owner-operators, employees of any such entity, or employees of any entity which furnishes persons to provide services on the project. "Services" includes, without limitation, providing, hauling or delivering equipment or materials, or providing labor, transportation, or other service related to a project. "Services" does not include activities unrelated to the project, such as food/beverage vendors, office supply deliveries, and delivery of portable toilets.

11.2 The Contractor shall provide coverage, based on proper reporting of classification code and payroll amounts and filing any coverage agreements, which meets the statutory requirements of Texas Labor Code, Section 401.011(44) for all employees of the Contractor providing services on the project, for the duration of the project.

11.3 The Contractor must provide a certificate of coverage to the governmental entity prior to being awarded the contract – refer to Section 10 above.

11.4 If the coverage period shown on the Contractor's current certificate of coverage ends during the duration of the project, the Contractor must, prior to the end of the coverage period, file a new certificate of coverage with the governmental entity showing that coverage has been extended.

11.5 The Contractor shall obtain from each person providing services on a project, and provide to the governmental entity:

11.5.1 A certificate of coverage, prior to that person beginning work on the project, so the governmental entity will have on file certificates of coverage showing coverage for all persons providing services on the project; and

11.5.2 No later than seven (7) days after receipt by the Contractor, a new certificate of coverage showing extension of coverage, if the coverage period shown on the current certificate ends during the duration of the project.

11.6 The Contractor shall retain all required certificates of coverage for the duration of the project and for one (1) year thereafter.

11.7 The Contractor shall notify the governmental entity in writing by certified mail or personal delivery, within ten (10) days after the contractor knew or should have known, of any change that materially affects the provision of coverage of any person providing services on the project.

11.8 The Contractor shall post on each project site a notice, in the text, form and manner prescribed by the Texas Department of Workers' Compensation, informing all persons providing services on the project that they are required to be covered, and stating how a person may verify coverage and report lack of coverage.

- 11.9 The Contractor shall contractually require each person with whom it contracts to provide services on a project to:
- 11.9.1 Provide coverage, based on reporting of classification codes and payroll amounts and filing of any coverage agreements, which meets the statutory requirements of Texas Labor Code, Section 401.011(44) for all its employees providing services on the project, for the duration of the project.
  - 11.9.2 Provide to the Contractor, prior to that person beginning work on the project a certificate of coverage showing that coverage is being provided for all employees of the person providing services on the project, for the duration of the project.
  - 11.9.3 Provide the Contractor, prior to the end of coverage period, a new certificate of coverage showing extension of coverage, if the coverage period shown on the current certificate of coverage ends during the duration of the project.
  - 11.9.4 Obtain from each person with whom it contracts, and provide to the Contractor:
    - 11.9.4.1 A certificate of coverage, prior to the other person beginning work on the project; and
    - 11.9.4.2 the coverage period, if the coverage period shown on the current certificate of a new certificate of coverage showing extension of coverage, prior to the end of coverage ends during the duration of the project.
  - 11.9.5 Retain all required certificates of coverage on file for the duration of the project and for one (1) year thereafter.
  - 11.9.6 Notify the governmental entity in writing by certified mail or personal delivery, within ten (10) days after the person knew or should have known, of any change that materially affects the provision of coverage of any person providing services on the project; and
  - 11.9.7 Contractually require each person with whom it contracts to perform as required by paragraphs 11.1. – 11.7., with the certificates of coverage to be provided to the person for whom they are providing services.
- 11.10 By signing this contract or providing or causing to be provided a certificate of coverage, the Contractor is representing to the governmental entity that all employees of the Contractor who will provide services of the project will be covered by workers' compensation coverage for the duration of the project, that the coverage will be based on proper reporting of classification codes and payroll amounts, and that all coverage agreements will be filed with the appropriate insurance carrier or, in the case of a self-insured, with the commission's Division of Self-Insurance Regulation. Providing false or misleading information may subject the Contractor to administrative penalties, criminal penalties, civil penalties, or other civil actions.
- 11.11 The Contractor's failure to comply with any of these provisions is a breach of contract by the Contractor which entitles the governmental entity to declare the contract void if the Contractor does not remedy the breach within ten (10) days after receipt of notice of breach from the governmental entity.

**BIDDER: INSERT COPY OF CERTIFICATE OF INSURANCE (COI) BEHIND THIS PAGE.**

Note: For bid purposes, a general COI will suffice. However, a COI that includes the notation that “Jefferson County as an additional insured” will be required from Awarded Bidder(s) prior to the issuance of a Purchase Order.

**BIDDER INFORMATION FORM**

---

Instructions: Complete the form below. Please provide legible, accurate, and complete contact information.  
PLEASE PRINT.

**Bid Number & Name:** (IFB 24-064/MR) Popeye Holmes Park Concrete Walkway Renovation

**Bidder's Company/Business Name:** \_\_\_\_\_

**Bidder's TAX ID Number:** \_\_\_\_\_

**If Applicable:** HUB Vendor No. \_\_\_\_\_ DBE Vendor No. \_\_\_\_\_

**Contact Person:** \_\_\_\_\_ **Title:** \_\_\_\_\_

**Phone Number (with area code):** \_\_\_\_\_

**Alternate Phone Number if available (with area code):** \_\_\_\_\_

**Fax Number (with area code):** \_\_\_\_\_

**Email Address:** \_\_\_\_\_

**Mailing Address (Please provide a physical address for bid bond return, if applicable):**

\_\_\_\_\_  
Address

\_\_\_\_\_  
City, State, Zip Code

**REQUIRED FORM**  
**Bidder: Please complete this form  
and include with bid submission.**

## SECTION 4: MINIMUM SPECIFICATIONS

---

The following requirements and specifications supersede General Bid Requirements where applicable. Any questions relating to bid submission or bid item specifications requirements should be directed to Mistey Reeves, Assistant Purchasing Agent at 409-835-8593 or via email at: [mistey.reeves@jeffcotx.us](mailto:mistey.reeves@jeffcotx.us). If no response in 72 hours, contact Deborah Clark, Purchasing Agent at 409-835-8593 or via email at: [deb.clark@jeffcotx.us](mailto:deb.clark@jeffcotx.us). Please reference Bid Number: IFB 24-064/MR.

### **SCOPE OF WORK**

It is the intent of the Contract Documents to provide the requirements and specification for the construction associated with Jefferson County Popeye Holmes Park Concrete Walkway Renovation which includes all labor, material and work required for removal and replacement of concrete walkway pavement as called out in the plans and specifications. The park is located on the grounds of the Jefferson County Sub-Courthouse located at 525 Lakeshore Drive, Port Arthur, Texas 77640.

The project requires that the construction be completed and ready for use by the Owner in the time specified in this document. CONTRACTOR TO PERFORM ALL WORK AS INDICATED ON THE PLANS AND SPECIFICATIONS. This contract shall provide for the necessary labor, overhead, supervision, equipment, tools, materials, and all other related construction items necessary for the proposed project all in strict accordance with the construction plans and specifications. Contractor is responsible for all damages caused by the contractor. This includes labor, materials and work required to repair damages. Project plans begin on page 65 of these specifications.

### **GENERAL SUMMARY OF WORK:**

The general summary of Concrete Walkway Renovation Project includes all labor, material and work to perform the following:

- Full depth saw cutting and removal of existing concrete walkway paving to the limits shown on the drawings
- Level, shape and fill ruts, in the area to be re-paved, with compacted structural fill
- Place 3,000 psi concrete walkway pavement including forming the detailed brick ledge, curing, all joint placement, joint cutting/grooving, sealing and concrete finishing
- Removal of formwork
- Install temporary brick pavers
- Backfill the formed edges of the new concrete walkway pavement with structural fill
- Provide and maintain orange safety fencing around the work zone until work is completed

### **GENERAL NOTES**

1. Procure all the necessary County permits and licenses before the start of this project. This will not be paid for directly but shall be considered subsidiary to various bid items of the contract. Contractor is responsible for all costs associated with permits and licenses.



2. Contractor is required to notify and request locates from the Texas One Call System prior to beginning any work. In Texas Call 811 or see the 811 website for information. Additional reference numbers are provided below

AT&T Communications	Entergy Distribution	CenterPoint Energy/ Entex
Beaumont, Texas 77701 (409) 839-7030 Randall Jennings	North 11 <sup>th</sup> Street Beaumont, Texas 77701 (409) 785-2136 Brian Cross	6090 College Street Beaumont, Texas 77707 (409) 860-7113 Tara Hunter
Spectrum 602 N. Hwy 69 Nederland, Texas 77627 Michael Ward (409) 720-5513	Jefferson County Engineering Dept (409) 835-8584 Michelle Falgout	Jefferson County Precinct #3 (409) 983-8300 Superintendent Kenneth Shepard

**This action does not relieve the Contractor of the responsibilities under the terms of the contract or the plans and specifications. Damage caused by the Contractor's operations shall be repaired and restored to service in a timely manner at no expense to Jefferson County.**

3. The approximate location of the known underground utility installations is shown on the plans. Contractor to confirm the location of these utility lines and the exact location of any others which may exist. Assume full responsibility for notifying the utility involved in case of conflict or damage and he/she shall be responsible for damage that occurs due to his/her negligence. Remove and dispose of abandoned lines encountered that interfere with the construction of this project. Consider this work to be subsidiary to the various bid items of the contract.
4. The proposed construction activity may cross or closely parallel existing storm water pipes, sanitary sewer and water lines. Contractor shall exercise caution to avoid damage to existing water or sewer service lines and shall be responsible for their repair if damaged.
5. Allow County forces to enter this project to accomplish such work as shown in the plans (by others) and as may be deemed necessary by the Engineer.
6. Maintain for the duration of this project, those sections of existing and proposed walkways and appurtenances which are to be constructed, reconstructed, modified, or remain in place under this project. Any portion of the area walkways and appurtenances damaged by the contractor's forces shall be repaired by the contractor at his/her expense. This shall include but is not limited to handrails, steps, storm pipes, MH tops, water valve tops, signage, asphalt paving, etc.
7. Place all equipment in an area designated by the County. All damages caused by the Contractor to grassy or landscaped areas, pavement, parking areas or any other area outside of the work area shall be repaired at his/her expense. Protect all areas of the park which are not included in the actual limits of the proposed construction areas from destruction. Restore any damaged areas to original or better condition. No payment will be made for this work.
8. All truck traffic transporting materials to and from the project are to access and depart from the project site utilizing routes approved by the Engineer or the Precinct. Millings, sand, or other approved materials may be used on adjacent roadway surfaces to absorb and therefore minimize tracking of the materials applied during the course of construction. Materials used for absorption shall be maintained for the duration of the project.

Upon completion of material applications, clean and dispose of absorption material in accordance with federal, state, and local regulations. This will not be paid for directly but shall be considered subsidiary to various bid items of the contract.

9. The Contractor shall restore all pavement sections or other structures that have been damaged by the Contractor to their original condition or better, in the opinion of the Engineer and the owner. This shall include any base section repairs that are necessary, in the opinion of the Engineer. There shall be no additional payment for damages to pavement or other structures.
10. Assume ownership for all excess or waste material, concrete, soils, or other debris and dispose of properly according to all State and Federal rules and regulations.
11. If overhead or underground power lines need to be de-energized/re-energized, contact the electrical service provider to perform this work. Costs associated with de-energizing/re-energizing the power lines or other protective measures required are at no expense to the County. If working near power lines, comply with the appropriate sections of Texas State Law and Federal Regulations relating to the type of work involved.
12. Material on hand will not be paid for.
13. Verify material quantities and dimensions prior to ordering materials.
14. The Contractor will establish the project control point, points, or tangency, PI's (points of intersection), point of curvature (PC, PI, and PT) and bench marks necessary to layout the project. Contractor shall establish and maintain these points throughout construction. There will be no separate payment for this work, but it shall be considered subsidiary to various bid items.
15. Any saw-cutting or other joint placement required for the project shall not be paid for directly but shall be considered subsidiary to various bid items.
16. The Contractor will notify the County 48 hours in advance of work. See Work Sequence/Scheduling on page 43 of these specifications for allowable working hours.
17. Bidders should visit the proposed project site to acquaint themselves with the site conditions and access limitations prior to bidding on the project. Bidding on the project shall be considered the Contractor's assurance that he is familiar with the site conditions and that his bid provides for reasonable unanticipated conditions. To schedule a site visit, contact Kenneth Sheperd, Pt. Arthur Maintenance Superintendent, at 409-983-8300. If no response in 24 hours, contact Mistey Reeves, Assistant Purchasing Agent, at 409-835-8593.
18. Sedimentation and environmental controls -
  - a. This item will not be paid for directly but considered subsidiary to various bid items.
  - b. The following temporary erosion, sediment and water control measures shall be required.
    - i. Contractor will be responsible for removing dirt from the roads and parking lots daily to prevent tracking.
    - ii. All concrete truck washout will be disposed of at the plant or in an Engineered approved containment area. The Containment area will be removed and disposed of once concrete placement is complete and the area restored to pre-construction conditions.
    - iii. Contractor shall police the construction area at the end of each day and remove and containerize all

trash

- iv. Pumped stormwater shall be channeled through a rock berm, erosion control log or other method to help prevent excessive discharge of silt.
  - i. Sedimentation and environmental controls -

19. All Bid Items shall be installed according to the TXDOT Item indicated in the plans and specifications per the 2014 TXDOT Standard Specifications for the Construction and Maintenance of Highways , Streets and Bridges.

#### **SPECIFICATIONS:**

##### **Bid Item 1 – Remove Existing Concrete Sidewalk - TXDOT Specification 104**

1. All concrete pavement will be saw cut full depth at connection points to existing pavements as noted on the drawings. Saw cutting of all concrete will not be measured or paid for directly but shall be considered subsidiary to various bid items.

##### **Bid Item 2 – 4” Concrete Sidewalk (in-place) – TXDOT Specification 360**

1. This bid item shall include all excavation, tree root removal, filling and compacting any ruts from tree root removal, filling and compacting of any soft spots. Fill ruts or soft spots with structural fill meeting the structural fill requirements shown on the plans. Payment for all excavation, tree root removal, filling or compacting associated with this item will be subsidiary to this item.
2. This bid item shall include all forming, joint placement, reinforcement, concrete placement, finishing and curing according to TXDOT Specification 360.
3. Sawing/Grooving of all joints shall begin as soon as sawing/grooving can be accomplished without damage to the pavement.
4. Class 5 self-leveling low modulus silicone sealant shall be used to seal expansion joints within repair areas on this project.
5. Saw cutting/grooving of all joints will not be paid for separately but shall be considered subsidiary to various bid items.
6. Light Broom Finish for final surface texture unless otherwise directed by the Engineer.
7. County shall be notified 48 hours prior to pouring concrete to inspect the subgrade and rebar installation. Bricks will not be allowed as chairs on this project. County shall be onsite for all pavement installation

##### **Bid Item 3 – Structural Fill**

1. Structural Fill meeting the requirements shown on the drawings shall be provided, installed and compacted to the density shown on the plans.
8. This bid item shall include the excavation, disposal of excavated materials, removal of tree roots necessary for the placement of the structural fill.
9. Payment for all excavation, tree root removal, filling or compacting and disposal of material associated with this item will be subsidiary to this item.

#### **Bid Item 4 – Temporary Brick Pavers**

1. Contractor shall provide and install Brick Pavers per the Attached Brick Specification for Pacific Clay Bricks (Bear Path:Dark Iron Spot) and shall install the bricks according to the Manufacturer Specifications, also attached.
2. The lineal feet of brick pavers shown on the bid form is measured along the outside edge of the brick ledge as shown on the drawings. Bricks are expected to be placed with the long side perpendicular to the edge of the concrete as dictated by the plan details
3. Contractor will consult with the County regarding the color and texture of the bricks prior to placing order.

#### **Bid Item 5– Mobilization**

1. Establish and remove offices and facilities. Move personnel, equipment, and supplies to and from the project or the vicinity of the project site to begin work or complete work on Contract Items. Bonds and insurance are required for performing mobilization.
2. Mobilization shall not exceed three (3) percent of the total construction items amount prior to the cost of mobilization being added.

#### **WORK SEQUENCE/SCHEDULING:**

It shall be the responsibility of the Contractor to coordinate all work with the County and any other party affected by this project.

Contractor shall complete the work in 50 calendar days from the date of the notice to proceed.

Work may be performed between the hours of 7:00 am and 4:00 pm Monday through Thursday unless otherwise approved by Jefferson County.

#### **SUBMITTALS:**

Contractor shall submit the following submittals for review within 10 days of receiving the notice to proceed:

- 1 Concrete Mix Design;
- 2 Source and spec sheet for the structural fill;
- 3 Schedule showing estimated work times and sequencing of project.

During construction the Contractor shall provide the County with

1. Concrete Tickets
2. Structural Fill Tickets
3. Brick Delivery Tickets verifying the type of brick specified in the plans.

#### **1 YEAR WARRANTY**

Contractor will provide an Affidavit of Warranty at the end of the project. A copy of the Warranty document is attached on page 44 of these specifications.

# AFFIDAVIT OF WARRANTY

CONTRACTOR: \_\_\_\_\_

PROJECT: \_\_\_\_\_ Jefferson County 2024 Popeye Holmes Park Concrete Walkway Renovation

LOCATION: \_\_\_\_\_

WORK PERFORMED: -. \_\_\_\_\_

FINAL CONTRACT AMOUNT: \$ \_\_\_\_\_

CONTRACT DATE: \_\_\_\_\_

CONTRACTOR warrants and guarantees to the OWNER and that all Work is in accordance with the Contract Documents and will not be defective. CONTRACTOR'S warranty and guarantee hereunder excludes defects or damage caused by;

- 1) Abuse, modification, or improper maintenance or operation by persons other than the CONTRACTOR, Sub-contractors, Suppliers, or any other individual or entity for whom the CONTRACTOR is responsible; or
- 2) Normal wear and tear under normal usage.

The Signing Officer, as titled, of said CONTRACTOR, does hereby Guarantee and Warranty in accordance with the Requirements (Plans and Specifications), all Labor and Materials on the said Project, and all work performed under the Contract between \_\_\_\_\_ AND JEFFERSON COUNTY and/or assign to be free from defects resulting from faulty Workmanship and/or Materials for the Guarantee Period extending from \_\_\_\_\_ through \_\_\_\_\_. Upon receipt of written notice from the OWNER or JEFFERSON COUNTY, the CONTRACTOR shall remedy the defects and replace any property damaged therefrom occurring within the warranty and guarantee period, as required.

SIGNING OFFICER: \_\_\_\_\_ DATE: \_\_\_\_\_

PRINTED NAME: \_\_\_\_\_ TITLE \_\_\_\_\_

Acknowledged by \_\_\_\_\_, Notary Public.

Printed Name \_\_\_\_\_

My Commission expires: \_\_\_\_\_

**OFFER AND ACCEPTANCE FORM  
OFFER TO CONTRACT**

---

To Jefferson County:

We hereby offer and agree to furnish the materials or service in compliance with all terms, conditions, specifications, and amendments in the Invitation for Bid and any written exceptions in the offer.

We understand that the items in this Invitation for Bid, including, but not limited to, all required certificates are fully incorporated herein as a material and necessary part of the contract.

The undersigned hereby states, under penalty of perjury, that all information provided is true, accurate, and complete, and states that he/she has the authority to submit this bid, which will result in a binding contract if accepted by Jefferson County.

We acknowledge receipt of the following amendment(s): \_\_\_\_\_, \_\_\_\_\_, \_\_\_\_\_, \_\_\_\_\_.

**I certify, under penalty of perjury, that I have the legal authorization to bind the firm hereunder:**

**For clarification of this offer, contact:**

\_\_\_\_\_  
Company Name

\_\_\_\_\_  
Address

\_\_\_\_\_  
City

State

\_\_\_\_\_  
Zip

\_\_\_\_\_  
Name & Title

\_\_\_\_\_  
Phone

\_\_\_\_\_  
Fax

\_\_\_\_\_  
Signature of Person Authorized to Sign

\_\_\_\_\_  
E-mail

\_\_\_\_\_  
Printed Name

\_\_\_\_\_  
Title

**REQUIRED FORM**

**Bidder: Please complete this form  
and include with bid submission.**

**ACCEPTANCE OF OFFER**

---

The Offer is hereby accepted for the following items: Popeye Holmes Park Concrete Walkway Renovation.

The Contractor is now bound to sell the materials or services listed by the attached contract and based upon the Invitation for Bid, including all terms, conditions, specifications, amendments, etc., and the Contractor's Offer as accepted by Jefferson County.

This contract shall henceforth be referred to as Contract No. (IFB 24-064/MR, Popeye Holmes Park Concrete Walkway Renovation. The Contractor has not been authorized to commence any billable work or to provide any material or service under this contract until Contractor receives a purchase order and/or a notice to proceed from the Jefferson County Purchasing Agent.

**COUNTERSIGNED:**

---

**Jeff R. Branick, County Judge**  
**JEFFERSON COUNTY, TEXAS**

---

**Date**

**ATTEST:**

---

**Roxanne Acosta Hellberg, County Clerk**  
**JEFFERSON COUNTY, TEXAS**

---

**Date**

**BIDDER: INSERT ALL ADDENDA BEHIND THIS PAGE.  
PLEASE BE SURE TO COMPLETE, SIGN, ATTEST, AND DATE EACH ADDENDUM.**



**BIDDER: INSERT BID SECURITY BEHIND THIS PAGE.**

**BID FORM**

<b>Bid Item</b>	<b>TXDOT Item</b>	<b>Bid Item Description</b>	<b>Unit</b>	<b>Estimated Quantity</b>	<b>Unit Price</b>	<b>Extended Amount (Total for Line Item)</b>
1	104	Remove Existing Concrete Sidewalk	SY	1687.0	\$	\$
2	360	4" Concrete Walkway (In Place)	SY	1687.0	\$	\$
3	132	Structural Fill (4" in Place)	SY	1687.00	\$	\$
4	Paver Specifications	Brick Pavers (In Place)	LF	255.0	\$	\$
5	500	Mobilization (Max 3%)	LS	1.0	\$	\$
					<b>TOTAL BID AMOUNT</b>	\$

**BIDDER ACKNOWLEDGEMENT OF BID ADDENDA (IF APPLICABLE):**

Addendum 1 \_\_\_\_\_ Date Received \_\_\_\_\_

Addendum 2 \_\_\_\_\_ Date Received \_\_\_\_\_

Addendum 3 \_\_\_\_\_ Date Received \_\_\_\_\_

**BIDDER: INCLUDE FULL, SIGNED, & ATTESTED COPY OF EACH ADDENDUM ISSUED WITH BID SUBMISSION.**

**REQUIRED FORM**

**Bidder: Please complete this form and include with bid submission.**

**VENDOR REFERENCES FORM**

Bidder: Please list at least three (3) companies or governmental agencies (preferably a municipality) where the same or similar products and/or services as contained in this specification package were recently provided.

**REQUIRED FORM**

**Bidder: Please complete this form and include with bid submission.**

**REFERENCE ONE**

Government/Company Name: \_\_\_\_\_

Address: \_\_\_\_\_

Contact Person and Title: \_\_\_\_\_

Phone: \_\_\_\_\_ Fax: \_\_\_\_\_

Email Address: \_\_\_\_\_ Contract Period: \_\_\_\_\_

Scope of Work:

**REFERENCE TWO**

Government/Company Name: \_\_\_\_\_

Address: \_\_\_\_\_

Contact Person and Title: \_\_\_\_\_

Phone: \_\_\_\_\_ Fax: \_\_\_\_\_

Email Address: \_\_\_\_\_ Contract Period: \_\_\_\_\_

Scope of Work:

**REFERENCE THREE**

Government/Company Name: \_\_\_\_\_

Address: \_\_\_\_\_

Contact Person and Title: \_\_\_\_\_

Phone: \_\_\_\_\_ Fax: \_\_\_\_\_

Email Address: \_\_\_\_\_ Contract Period: \_\_\_\_\_

Scope of Work: \_\_\_\_\_

**SIGNATURE PAGE**

---

As permitted under Article 4413 (32c) V.A.C.S., other governmental entities may wish to participate under the same terms and conditions contained in this contract (i.e., piggyback). In the event any other entity participates, all purchase orders will be issued directly from and shipped directly to the entity requiring supplies/services. Jefferson County shall not be held responsible for any orders placed, deliveries made or payment for supplies/services ordered by another entity. Each entity reserves the right to determine their participation in this contract.

Would Bidder be willing to allow other governmental entities to piggyback off this contract, if awarded, under the same terms and conditions? .....**Yes**  **No**

This bid shall remain in effect for ninety (90) days from bid opening and shall be exclusive of federal excise and state and local sales tax (exempt).

The undersigned agrees, if this bid is accepted, to furnish any and all items upon which prices are offered, at the price and upon the terms and conditions contained in the Invitation for Bid, Conditions of Bidding, Terms of Contract, and Specifications and all other items made a part of the accepted contract.

The undersigned affirms that they are duly authorized to execute the contract, that this company, corporation, firm, partnership or individual has not prepared this bid in collusion with any other Bidder, and that the contents of this bid as to prices, terms or conditions of said bid have not been communicated by the undersigned nor by any employee or agent to any other Bidder or to any other person(s) engaged in this type of business prior to the official opening of this bid. And further, that neither the Bidder nor their employees nor agents have been for the past six (6) months directly nor indirectly concerned in any pool or agreement or combination to control the price of goods or services on, nor to influence any person to bid or not to bid thereon.

\_\_\_\_\_  
Bidder (Entity Name)

\_\_\_\_\_  
Signature

\_\_\_\_\_  
Street & Mailing Address

\_\_\_\_\_  
Print Name

\_\_\_\_\_  
City, State & Zip

\_\_\_\_\_  
Date Signed

\_\_\_\_\_  
Telephone Number

\_\_\_\_\_  
Fax Number

\_\_\_\_\_  
E-mail Address

<p><b>REQUIRED FORM</b> <b>Bidder: Please complete this form</b> <b>and include with bid submission.</b></p>
--

## CERTIFICATION REGARDING LOBBYING

---

Certification for Contracts, Grants, Loans, and Cooperative Agreements

The undersigned certifies, to the best of his or her knowledge and belief, that:

1. No Federal appropriated funds have been paid or will be paid, by or on behalf of the undersigned, to any person for influencing or attempting to influence an officer or employee of an agency, a Member of Congress, an officer or employee of Congress, or an employee of a Member of Congress in connection with the awarding of any Federal contract, the making of any Federal grant, the making of any Federal loan, the entering into of any cooperative agreement, and the extension, continuation, renewal, amendment, or modification of any Federal contract, grant, loan, or cooperative agreement.
  
2. If any funds other than Federal appropriated funds have been paid or will be paid to any person for influencing or attempting to influence an officer or employee of any agency, a Member of Congress, an officer or employee of Congress, or an employee of a Member of Congress in connection with this Federal contract, grant, loan, or cooperative agreement, the undersigned shall complete and submit Standard Form-LLL, "Disclosure Form to Report Lobbying," in accordance with its instructions.
  
3. The undersigned shall require that the language of this certification be included in the award documents for all subawards at all tiers (including subcontracts, subgrants, and contracts under grants, loans, and cooperative agreements) and that all subrecipients shall certify and disclose accordingly.

This certification is a material representation of fact upon which reliance was placed when this transaction was made or entered into. Submission of this certification is a prerequisite for making or entering into this transaction imposed by section 1352, title 31, U.S. Code. Any person who fails to file the required certification shall be subject to a civil penalty of not less than \$10,000 and not more than \$100,000 for each such failure.

The Contractor, certifies or affirms the truthfulness and accuracy of each statement of its certification and disclosure, if any. In addition, the Contractor understands and agrees that the provisions of 31 U.S.C. Chap. 38, Administrative Remedies for False Claims and Statements, apply to this certification and disclosure, if any.

<b>Signature of Contractor's Authorized Official</b>
<b>Name and Title of Contractor's Authorized Official</b> <i>(Please Print)</i>
<b>Date</b>

<b>REQUIRED FORM</b> <b><u>Bidder:</u> Please complete this form and include with bid submission.</b>
--

# CONFLICT OF INTEREST QUESTIONNAIRE

<b>CONFLICT OF INTEREST QUESTIONNAIRE</b> For vendor doing business with local governmental entity		<b>FORM CIQ</b>
<p><b>This questionnaire reflects changes made to the law by H.B. 23, 84th Leg., Regular Session.</b></p> <p>This questionnaire is being filed in accordance with Chapter 176, Local Government Code, by a vendor who has a business relationship as defined by Section 176.001(1-a) with a local governmental entity and the vendor meets requirements under Section 176.006(a).</p> <p>By law this questionnaire must be filed with the records administrator of the local governmental entity not later than the 7th business day after the date the vendor becomes aware of facts that require the statement to be filed. See Section 176.006(a-1), Local Government Code.</p> <p>A vendor commits an offense if the vendor knowingly violates Section 176.006, Local Government Code. An offense under this section is a misdemeanor.</p>	<b>OFFICE USE ONLY</b>	
<p><b>1</b> Name of vendor who has a business relationship with local governmental entity.</p>	Date Received	
<p><b>2</b> <input type="checkbox"/> Check this box if you are filing an update to a previously filed questionnaire.</p> <p>(The law requires that you file an updated completed questionnaire with the appropriate filing authority not later than the 7th business day after the date on which you became aware that the originally filed questionnaire was incomplete or inaccurate.)</p>		
<p><b>3</b> Name of local government officer about whom the information in this section is being disclosed.</p> <p style="text-align: center;">_____</p> <p style="text-align: center;">Name of Officer</p> <p>This section (item 3 including subparts A, B, C, &amp; D) must be completed for each officer with whom the vendor has an employment or other business relationship as defined by Section 176.001(1-a), Local Government Code. Attach additional pages to this Form CIQ as necessary.</p> <p>A. Is the local government officer named in this section receiving or likely to receive taxable income, other than investment income, from the vendor?</p> <p style="text-align: center;"><input type="checkbox"/> Yes      <input type="checkbox"/> No</p> <p>B. Is the vendor receiving or likely to receive taxable income, other than investment income, from or at the direction of the local government officer named in this section AND the taxable income is not received from the local governmental entity?</p> <p style="text-align: center;"><input type="checkbox"/> Yes      <input type="checkbox"/> No</p> <p>C. Is the filer of this questionnaire employed by a corporation or other business entity with respect to which the local government officer serves as an officer or director, or holds an ownership interest of one percent or more?</p> <p style="text-align: center;"><input type="checkbox"/> Yes      <input type="checkbox"/> No</p> <p>D. Describe each employment or business and family relationship with the local government officer named in this section.</p>		
<p><b>4</b></p> <p style="text-align: center;">_____</p> <p style="text-align: center;">Signature of vendor doing business with the governmental entity      Date</p>		

Adopted 8/7/2015

**REQUIRED FORM**  
**Bidder: Please complete this form and include with bid submission.**

**LOCAL GOVERNMENT OFFICER  
CONFLICTS DISCLOSURE STATEMENT – OFFICE USE ONLY**

<b>LOCAL GOVERNMENT OFFICER CONFLICTS DISCLOSURE STATEMENT</b>		<b>FORM CIS</b>
<p>This questionnaire reflects changes made to the law by H.B. 23, 84th Leg., Regular Session.</p> <p>This is the notice to the appropriate local governmental entity that the following local government officer has become aware of facts that require the officer to file this statement in accordance with Chapter 176, Local Government Code.</p>		<b>OFFICE USE ONLY</b>
<b>1</b>	<b>Name of Local Government Officer</b>	Date Received
<b>2</b>	<b>Office Held</b>	
<b>3</b>	<b>Name of vendor described by Sections 176.001(7) and 176.003(a), Local Government Code</b>	
<b>4</b>	<b>Description of the nature and extent of employment or other business relationship with vendor named in item 3</b>	
<b>5</b>	<p><b>List gifts accepted by the local government officer and any family member, if aggregate value of the gifts accepted from vendor named in item 3 exceeds \$100 during the 12-month period described by Section 176.003(a)(2)(B).</b></p> <p>Date Gift Accepted _____ Description of Gift _____</p> <p>Date Gift Accepted _____ Description of Gift _____</p> <p>Date Gift Accepted _____ Description of Gift _____</p> <p style="text-align: center;">(attach additional forms as necessary)</p>	
<b>6</b>	<p><b>AFFIDAVIT</b></p> <p>I swear under penalty of perjury that the above statement is true and correct. I acknowledge that the disclosure applies to each family member (as defined by Section 176.001(2), Local Government Code) of this local government officer. I also acknowledge that this statement covers the 12-month period described by Section 176.003(a)(2)(B), Local Government Code.</p> <p style="text-align: right; margin-right: 100px;">_____</p> <p style="text-align: right; margin-right: 100px;">Signature of Local Government Officer</p> <p>AFFIX NOTARY STAMP / SEAL ABOVE</p> <p>Sworn to and subscribed before me, by the said _____, this the _____ day of _____, 20 _____, to certify which, witness my hand and seal of office.</p> <p>_____ Signature of officer administering oath      Printed name of officer administering oath      Title of officer administering oath</p>	

Adopted 8/7/2015

**THIS FORM IS FOR  
OFFICE USE ONLY**

## GOOD FAITH EFFORT (GFE) DETERMINATION CHECKLIST

---

Bidder intends to utilize Subcontractors/Subconsultants in the fulfillment of this contract (if awarded).

Yes  No

**Instructions:** In order to determine if a “Good Faith Effort” was made in soliciting HUBs for subcontracting opportunities, the following checklist and supporting documentation shall be completed by the Prime Contractor/Consultant, and returned with the Prime Contractor/ Consultant’s bid. This list contains the **minimum** efforts that should be put forth by the Prime Contractor/Consultant when attempting to achieve or exceed the goals of HUB Subcontractor participation. The Prime Contractor/Consultant may extend his/her efforts in soliciting HUB Subcontractor participation beyond what is listed below.

### Did the Prime Contractor/Consultant . . . ?

- |                              |                             |   |
|------------------------------|-----------------------------|---|
| <input type="checkbox"/> Yes | <input type="checkbox"/> No | 1. To the extent practical, and consistent with standard and prudent industry standards, divide the contract work into the smallest feasible portions, to allow for maximum HUB Subcontractor participation?  |
| <input type="checkbox"/> Yes | <input type="checkbox"/> No | 2. <b>Notify</b> in writing a reasonable number of HUBs, allowing sufficient time for effective participation of the planned work to be subcontracted?  |
| <input type="checkbox"/> Yes | <input type="checkbox"/> No | 3. <b>Provide</b> HUBs that were genuinely interested in bidding on a Subcontractor, adequate information regarding the project (i.e., plans, specifications, scope of work, bonding and insurance requirements, and a point of contact within the Prime Contractor/Consultant’s organization)? |
| <input type="checkbox"/> Yes | <input type="checkbox"/> No | 4. <b>Negotiate</b> in good faith with interested HUBs, and not reject bids from HUBs that qualify as lowest and responsive Bidders?  |
| <input type="checkbox"/> Yes | <input type="checkbox"/> No | 5. <b>Document</b> reasons HUBs were rejected? Was a written rejection notice, including the reason for rejection, provided to the rejected HUBs?   |
| <input type="checkbox"/> Yes | <input type="checkbox"/> No | 6. If Prime Contractor/Consultant has zero (0) HUB participation, <b>please explain the reasons why.</b>  |

**If “No” was selected, please explain and include any pertinent documentation with your bid.  
If necessary, please use a separate sheet to answer the above questions.**

---

Printed Name of Authorized Representative

---

Signature

---

Title

---

Date

**REQUIRED FORM**

**Bidder: Please complete this form  
and include with bid submission.**



**NOTICE OF INTENT (NOI) TO SUBCONTRACT WITH  
HISTORICALLY UNDERUTILIZED BUSINESS (HUB)**

Bidder intends to utilize Subcontractors/Subconsultants in the fulfillment of this contract (if awarded).

Yes  No

**Instructions for Prime Contractor/Consultant: Bidder shall submit this form with the bid; however, the information below may be submitted after contract award, but prior to beginning performance on the contract.**

Please submit one form for each HUB Subcontractor/Subconsultant with proper signatures, per the terms and conditions of your contract.

Contractor Name: \_\_\_\_\_ HUB:  Yes  No

Address: \_\_\_\_\_  
Street City State Zip

Phone (with area code): \_\_\_\_\_ Fax (with area code): \_\_\_\_\_

Project Title & No.: \_\_\_\_\_

Prime Contract Amount: \$ \_\_\_\_\_

HUB Subcontractor Name: \_\_\_\_\_

HUB Status (Gender & Ethnicity): \_\_\_\_\_

Certifying Agency:  Tx. Bldg & Procurement Comm.  Jefferson County  Tx Unified Certification Prog.

Address: \_\_\_\_\_  
Street City State Zip

Phone (with area code): \_\_\_\_\_ Fax (with area code): \_\_\_\_\_

Proposed Subcontract Amount: \$ \_\_\_\_\_ Percentage of Prime Contract: \_\_\_\_\_ %

Description of Subcontract Work to be Performed: \_\_\_\_\_

\_\_\_\_\_  
Printed Name of Contractor Representative Signature of Representative Date

\_\_\_\_\_  
Printed Name of HUB Signature of Representative Date

**Note: Nothing on this Notice of Intent Form is intended to confer any rights, expressed or implied, to any third parties.**  
Pre-Approval for Subcontractor Substitutions must be obtained from the Jefferson County Purchasing Agent's Representative. The "HUB Subcontractor/Subconsultant Change Form" must be completed and faxed to 409-835-8456.

**REQUIRED FORM**  
**Bidder: Please complete this form and include with bid submission.**

**HISTORICALLY UNDERUTILIZED BUSINESS (HUB)  
SUCONTRACTING PARTICIPATION DECLARATION FORM**

PAGE 1 OF 4

Bidder intends to utilize Subcontractors/Subconsultants in the fulfillment of this contract (if awarded).

Yes  No

Prime Contractor: \_\_\_\_\_ HUB:  Yes  No

HUB Status (Gender & Ethnicity): \_\_\_\_\_

Address: \_\_\_\_\_  
Street City State Zip

Phone (with area code): \_\_\_\_\_ Fax (with area code): \_\_\_\_\_

Project Title & No.: \_\_\_\_\_ IFB/RFP No.: \_\_\_\_\_

Total Contract: \$ \_\_\_\_\_ Total HUB Subcontract(s): \$ \_\_\_\_\_

Construction HUB Goals: 12.8% MBE: \_\_\_\_\_ % 12.6% WBE: \_\_\_\_\_ %

Sub-goals: 1.7 African-American, 9.7% Hispanic, 0.7% Native American, 0.8% Asian American.  
Use these goals as a guide to diversify.

**FOR HUB OFFICE USE ONLY:**

Verification date HUB Program Office reviewed and verified HUB Sub information Date: \_\_\_\_\_ Initials: \_\_\_\_\_

**PART I. HUB SUBCONTRACTOR DISCLOSURE**

HUB Subcontractor Name: \_\_\_\_\_

HUB Status (Gender & Ethnicity): \_\_\_\_\_

Certifying Agency:  Texas Bldg & Procurement Comm.  Texas Unified Certification Prog.

Address: \_\_\_\_\_  
Street City State Zip

Contact person: \_\_\_\_\_ Title: \_\_\_\_\_

Phone (with area code): \_\_\_\_\_ Fax (with area code): \_\_\_\_\_

Proposed Subcontract Amount: \$ \_\_\_\_\_ Percentage of Prime Contract: \_\_\_\_\_ %

Description of Subcontract Work to be Performed: \_\_\_\_\_

**REQUIRED FORM**

**Bidder: Please complete this form  
and include with bid submission.**

**HISTORICALLY UNDERUTILIZED BUSINESS (HUB)  
SUBCONTRACTING PARTICIPATION DECLARATION FORM**

PAGE 2 OF 4

**HUB Subcontractor Disclosure**

**PART I: Continuation Sheet (Duplicate as Needed)**

HUB Subcontractor Name: \_\_\_\_\_

HUB Status (Gender & Ethnicity): \_\_\_\_\_

Certifying Agency:      Tx. Bldg & Procurement Comm.    Jefferson County    Tx Unified Certification Prog.

Address: \_\_\_\_\_  
  Street    City    State    Zip

Contact person: \_\_\_\_\_ Title: \_\_\_\_\_

Phone (with area code): \_\_\_\_\_ Fax (with area code): \_\_\_\_\_

Proposed Subcontract Amount:     \$ \_\_\_\_\_ Percentage of Prime Contract: \_\_\_\_\_ %

Description of Subcontract Work to be Performed: \_\_\_\_\_

HUB Subcontractor Name: \_\_\_\_\_

HUB Status (Gender & Ethnicity): \_\_\_\_\_

Certifying Agency:      Tx. Bldg & Procurement Comm.    Jefferson County    Tx Unified Certification Prog.

Address: \_\_\_\_\_  
  Street    City    State    Zip

Contact person: \_\_\_\_\_ Title: \_\_\_\_\_

Phone (with area code): \_\_\_\_\_ Fax (with area code): \_\_\_\_\_

Proposed Subcontract Amount:     \$ \_\_\_\_\_ Percentage of Prime Contract: \_\_\_\_\_ %

Description of Subcontract Work to be Performed: \_\_\_\_\_

**All HUB Subcontractor Participation may be verified with the  
HUB Subcontractor(s) listed on Part I.**

**REQUIRED FORM**  
**Bidder: Please complete this form**  
**and include with bid submission.**

**HISTORICALLY UNDERUTILIZED BUSINESS (HUB)  
SUBCONTRACTING PARTICIPATION DECLARATION FORM**

PAGE 3 OF 4

**PART II: STATEMENT OF NON-COMPLIANCE FOR NOT MEETING HUB SUBCONTRACTING GOALS**

**Instructions to Bidder: Please complete Good Faith Effort (GFE) Checklist and attach any supporting documentation.**

Our firm was unable to meet the HUB goals for this project for the following reasons:

- All Subcontractors to be utilized are "Non-HUBs." (Complete Part III)
- HUBs were solicited but did not respond.
- HUBs solicited were not competitive.
- HUBs were unavailable for the following trade(s):
- Other: \_\_\_\_\_

Was the Jefferson County HUB Office contacted for assistance in locating HUBs?  Yes  No

---

**PART III: DISCLOSURE OF OTHER "NON-HUB" SUBCONTRACTS**

The Bidder shall use this area to provide a listing of all "Non-HUB" Subcontractors, including suppliers, that will perform under this project. A list of those "Non-HUB" Subcontractors the Bidder selects, after bid submission, shall be provided to the Purchasing Office not later than five (5) calendar days after being notified that Bidder is the apparent low Bidder. A list of those "Non-HUB" Subcontractors that are selected after contract award must be provided **immediately** after their selection.

Subcontractor Name: \_\_\_\_\_

Address: \_\_\_\_\_  
Street City State Zip

Contact person: \_\_\_\_\_ Title: \_\_\_\_\_

Phone (with area code): \_\_\_\_\_ Fax (with area code): \_\_\_\_\_

Proposed Subcontract Amount: \$ \_\_\_\_\_ Percentage of Prime Contract: \_\_\_\_\_ %

Description of Subcontract Work to be Performed: \_\_\_\_\_

---

Subcontractor Name: \_\_\_\_\_

Address: \_\_\_\_\_  
Street City State Zip

Contact person: \_\_\_\_\_ Title: \_\_\_\_\_

Phone (with area code): \_\_\_\_\_ Fax (with area code): \_\_\_\_\_

Proposed Subcontract Amount: \$ \_\_\_\_\_ Percentage of Prime Contract: \_\_\_\_\_ %

Description of Subcontract Work to be Performed: \_\_\_\_\_

**REQUIRED FORM**  
**Bidder: Please complete this form**  
**and include with bid submission.**

**HISTORICALLY UNDERUTILIZED BUSINESS (HUB)  
SUBCONTRACTING PARTICIPATION DECLARATION FORM**

PAGE 4 OF 4

Subcontractor Name: \_\_\_\_\_

Address: \_\_\_\_\_  
                                    Street                                    City                                    State                                    Zip

Contact person: \_\_\_\_\_ Title: \_\_\_\_\_

Phone (with area code): \_\_\_\_\_ Fax (with area code): \_\_\_\_\_

Proposed Subcontract Amount:       \$ \_\_\_\_\_ Percentage of Prime Contract: \_\_\_\_\_ %

Description of Subcontract Work to be Performed: \_\_\_\_\_

---

Subcontractor Name: \_\_\_\_\_

Address: \_\_\_\_\_  
                                    Street                                    City                                    State                                    Zip

Contact person: \_\_\_\_\_ Title: \_\_\_\_\_

Phone (with area code): \_\_\_\_\_ Fax (with area code): \_\_\_\_\_

Proposed Subcontract Amount:       \$ \_\_\_\_\_ Percentage of Prime Contract: \_\_\_\_\_ %

Description of Subcontract Work to be Performed: \_\_\_\_\_

---

I hereby certify that I have read the *HUB Program Instructions and Information*, truthfully completed all applicable parts of this form, and **attached any necessary support documentation as required**. I fully understand that intentionally falsifying information on this document may result in my not receiving a contract award or termination of any resulting contract.

Name (print or type): \_\_\_\_\_

Title: \_\_\_\_\_

Signature: \_\_\_\_\_

Date: \_\_\_\_\_

E-mail address: \_\_\_\_\_

Contact person that will be in charge of invoicing for this project:

Name (print or type): \_\_\_\_\_

Title: \_\_\_\_\_

Date: \_\_\_\_\_

E-mail address: \_\_\_\_\_

**REQUIRED FORM**  
**Bidder: Please complete this form and include with bid submission.**

**RESIDENCE CERTIFICATION/TAX FORM**

Pursuant to Texas Government Code §2252.001 *et seq.*, as amended, Jefferson County requests Resident Certification. §2252.001 *et seq.* of the Government Code provides some restrictions on the awarding of governmental contracts; pertinent provisions of §2252.001 are stated below:

- (3) "Non-resident Bidder" refers to a person who is not a resident.
- (4) "Resident Bidder" refers to a person whose principal place of business is in this state, including a contractor whose ultimate parent company or majority owner has its principal place of business in this state.

- I certify that \_\_\_\_\_ [company name] is a Resident Bidder of Texas as defined in Government Code §2252.001.
- I certify that \_\_\_\_\_ [company name] is a Nonresident Bidder as defined in Government Code §2252.001 and our principal place of business is \_\_\_\_\_ (city and state).

Taxpayer Identification Number (T.I.N.):	
Company Name submitting bid/proposal:	
Mailing address:	
If you are an individual, list the names and addresses of any partnership of which you are a general partner:	

**Property:** List all taxable property owned by you or above partnerships in Jefferson County.

Jefferson County Tax Acct. No.*	Property address or location**

\* This is the property amount identification number assigned by the Jefferson County Appraisal District.  
 \*\* For real property, specify the property address or legal description. For business property, specify the address where the property is located. For example, office equipment will normally be at your office, but inventory may be stored as a warehouse or other location.

**REQUIRED FORM**  
**Bidder: Please complete this form and include with bid submission.**

**HOUSE BILL 89 VERIFICATION**

---

I, \_\_\_\_\_, the undersigned representative of (company or business name) \_\_\_\_\_ (heretofore referred to as company) being an adult over the age of eighteen (18) years of age, after being duly sworn by the undersigned notary, do hereby depose and verify under oath that the company named above, under the provisions of Subtitle F, Title 10, Government Code Chapter 2270:

1. Does not boycott Israel currently; and
2. Will not boycott Israel during the term of the contract.

**Pursuant to Section 2270.002, Texas Government Code:**

1. **“Boycott Israel”** means refusing to deal with, terminating business activities with, or otherwise taking any action that is intended to penalize, inflict economic harm on, or limit commercial relations specifically with Israel, or with a person or entity doing business in Israel or in an Israeli-controlled territory, but does not include an action made ordinary business purposes; and
2. **“Company”** means a for-profit sole proprietorship, organization, association, corporation, partnership, joint venture, limited partnership, limited liability partnership, or an limited liability company, including a wholly owned subsidiary, majority-owned subsidiary, parent company or affiliate of those entities or business association that exist to make a profit.

\_\_\_\_\_  
Signature of Company Representative

\_\_\_\_\_  
Date

On this \_\_\_\_\_ day of \_\_\_\_\_, 20\_\_\_\_, personally appeared

\_\_\_\_\_, the above-named person, who after by me being duly sworn, did swear and confirm that the above is true and correct.

Notary Seal

\_\_\_\_\_  
**Notary Signature**

\_\_\_\_\_  
**Date**

<p style="text-align: center;"><b>REQUIRED FORM</b> <b><u>Bidder</u>: Please complete this form and include with bid submission.</b></p>
--

**SENATE BILL 252 CERTIFICATION**

---

On this day, I, Deborah L. Clark, Purchasing Agent for Jefferson County, Texas, pursuant to Texas Government Code, Chapter 2252, Section 2252.152 and Section 2252.153, certify that I did review the website of the Comptroller of the State of Texas concerning the listing of companies that is identified under Section 806.051, Section 807.051, or Section 2253.253 and I have ascertained that the below named company is not contained on said listing of companies which do business with Iran, Sudan, or any Foreign Terrorist Organization.

\_\_\_\_\_  
**Company Name**

\_\_\_\_\_  
**IFB/RFP/RFQ number**

**Certification check performed by:**

\_\_\_\_\_  
**Purchasing Representative**

\_\_\_\_\_  
**Date**

**THIS FORM IS FOR  
OFFICE USE ONLY**



**BID AFFIDAVIT**

The undersigned certifies that the bid prices contained in this bid have been carefully reviewed and are submitted as correct and final. Bidder further certifies and agrees to furnish any and/or all commodities upon which prices are extended at the price offered, and upon the conditions contained in the specifications and the Notice to Bidders.

STATE OF \_\_\_\_\_ COUNTY OF \_\_\_\_\_

BEFORE ME, the undersigned authority, a Notary Public in and for the State of \_\_\_\_\_,

on this day personally appeared \_\_\_\_\_, who  
(name)

after being by me duly sworn, did depose and say:

"I, \_\_\_\_\_ am a duly authorized officer of/agent  
(name)  
for \_\_\_\_\_ and have been duly authorized to execute the  
(name of firm)  
foregoing on behalf of the said \_\_\_\_\_.  
(name of firm)

I hereby certify that the foregoing bid has not been prepared in collusion with any other Bidder or other person or persons engaged in the same line of business prior to the official opening of this bid. Further, I certify that the Bidder is not now, nor has been for the past six (6) months, directly or indirectly concerned in any pool or agreement or combination, to control the price of services/commodities bid on, or to influence any person or persons to bid or not to bid thereon."

Name and address of Bidder: \_\_\_\_\_

Fax: \_\_\_\_\_ Telephone# \_\_\_\_\_

by: \_\_\_\_\_ Title: \_\_\_\_\_  
(print name)

Signature: \_\_\_\_\_

SUBSCRIBED AND SWORN to before me by the above-named

\_\_\_\_\_ on

this the \_\_\_\_\_ day of \_\_\_\_\_, 20\_\_.

**REQUIRED FORM**  
**Bidder: Please complete this form**  
**and include with bid submission.**

\_\_\_\_\_  
Notary Public in and for  
the State of \_\_\_\_\_

JEFFERSON COUNTY  
ENGINEERING DEPARTMENT

---

PLANS OF PROPOSED  
CONCRETE WALKWAY RENOVATION  
JEFFERSON COUNTY SUB-COURTHOUSE  
525 LAKESHORE DRIVE, PORT ARTHUR, TX 77642

SHEET INDEX

SHEET NO.	DESCRIPTION
1	TITLE SHEET
2 - 4	GENERAL NOTES AND SPECIFICATIONS
5	QUANTITY SUMMARY
6	EXISTING PLAN
7	PROPOSED PLAN
8	DETAILS

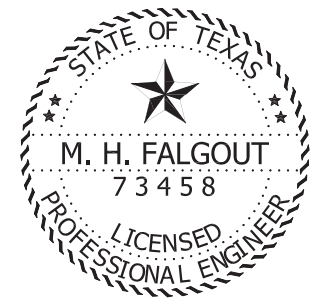

*Michelle Falgout* P.E.  
M.H.FALGOUT

REGISTERED PROFESSIONAL ENGINEER NO. 73458

DATE: 10-16-2024



JEFFERSON COUNTY

**POPEYE HOLMES PARK  
CONCRETE WALKWAY  
RENOVATION**

JEFFERSON COUNTY PRECINCT NO.3

SHEET 1 OF 1  
Page 65 of 72

DESIGN	J.D.	TITLE SHEET	SHEET NO.
CHECKED	M.F.		1

**DIVISION I  
SCOPE OF WORK, GENERAL NOTES AND SPECIFICATIONS  
JEFFERSON COUNTY**

**POPEYE HOLMES PARK  
CONCRETE WALKWAY RENOVATION**

**SCOPE OF WORK**

It is the intent of the Contract Documents to provide the requirements and specification for the construction associated with Jefferson County Popeye Holmes Park Concrete Walkway Renovation which generally includes but is not limited to: removal and replacement of concrete walkway pavement as called out in the plans and specifications. The park is located on the grounds of the Jefferson County Sub-Courthouse in Port Arthur, Texas.

The project requires that the construction be completed and ready for use by the Owner in the time specified in this document. CONTRACTOR TO PERFORM ALL WORK AS INDICATED ON THE PLANS AND SPECIFICATIONS. This contract shall provide for the necessary labor, overhead, supervision, equipment, tools, materials, and all other related construction items necessary for the proposed project all in strict accordance with the construction plans and specifications.

**GENERAL SUMMARY OF WORK:**

The general summary of Concrete Walkway Renovation Project includes, but is not limited to the following:

- Full depth saw cutting and removal of existing concrete walkway paving to the limits shown on the drawings
- Level, shape and fill ruts, in the area to be re-paved, with compacted structural fill
- Place 3,000 psi concrete walkway pavement including forming the detailed brick ledge, curing, all joint placement, joint cutting/grooving, sealing and concrete finishing
- Removal of formwork
- Install temporary brick pavers
- Backfill the formed edges of the new concrete walkway pavement with structural fill
- Provide and maintain orange safety fencing around the work zone until work is completed

**GENERAL NOTES**

1. Procure all the necessary County permits and licenses before the start of this project. This will not be paid for directly but shall be considered subsidiary to various bid items of the contract.
2. Contractor is required to notify and request locates from the Texas One Call System prior to beginning any work. In Texas Call 811 or see the 811 website for information. Additional reference numbers are provided below

AT&T Communications	Entergy Distribution	CenterPoint Energy/ Entex
Beaumont, Texas 77701	North 11 <sup>th</sup> Street	6090 College Street

(409) 839-7030  
Randall Jennings

Spectrum  
602 N. Hwy 69  
Nederland, Texas 77627  
Michael Ward  
(409) 720-5513

Beaumont, Texas 77701  
(409) 785-2136  
Brian Cross

Jefferson County  
Engineering Dept  
(409) 835-8584  
Michelle Falgout

Beaumont, Texas 77707  
(409) 860-7113  
Tara Hunter

Jefferson County  
Precinct #3  
Maintenance  
Superintendent  
Kenneth Shepard

**This action does not relieve the Contractor of the responsibilities under the terms of the contract or the plans and specifications. Damage caused by the Contractor's operations shall be repaired and restored to service in a timely manner at no expense to Jefferson County.**

3. The approximate location of the known underground utility installations is shown on the plans. Contractor to confirm the location of these utility lines and the exact location of any others which may exist. Assume full responsibility for notifying the utility involved in case of conflict or damage and he/she shall be responsible for damage that occurs due to his/her negligence. Remove and dispose of abandoned lines encountered that interfere with the construction of this project. Consider this work to be subsidiary to the various bid items of the contract.
4. The proposed construction activity may cross or closely parallel existing storm water pipes, sanitary sewer and water lines. Contractor shall exercise caution to avoid damage to existing water or sewer service lines and shall be responsible for their repair if damaged.
5. Allow County forces to enter this project to accomplish such work as shown in the plans (by others) and as may be deemed necessary by the Engineer.
6. Maintain for the duration of this project, those sections of existing and proposed walkways and appurtenances which are to be constructed, reconstructed, modified, or remain in place under this project. Any portion of the area walkways and appurtenances damaged by the contractor's forces shall be repaired by the contractor at his/her expense. This shall include but is not limited to handrails, steps, storm pipes, MH tops, water valve tops, signage, asphalt paving, etc.
7. Place all equipment in an area designated by the County. All damages caused by the Contractor to grassy or landscaped areas, pavement, parking areas or any other area outside of the work area shall be repaired at his/her expense. Protect all areas of the park which are not included in the actual limits of the proposed construction areas from destruction. Restore any damaged areas to original or better condition. No payment will be made for this work.
8. All truck traffic transporting materials to and from the project are to access and depart from the project site utilizing routes approved by the Engineer or the Precinct. Millings, sand, or other approved materials may be used on adjacent roadway surfaces to absorb and therefore minimize tracking of the materials applied during the course of construction. Materials used for absorption shall be maintained for the duration of the project. Upon completion of material applications, clean and dispose of absorption material in accordance with federal, state, and local regulations. This will not be paid for directly but shall be considered subsidiary to various bid items of the contract.
9. The Contractor shall restore all pavement sections or other structures that have been damaged by the Contractor to their original condition or better, in the opinion of the Engineer and the owner.

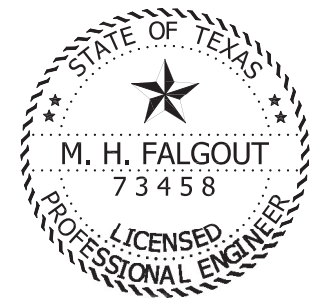

*Michelle Falgout* P.E.  
**M.H.FALGOUT**  
REGISTERED PROFESSIONAL ENGINEER NO. 73458  
**DATE: 10-16-2024**



**POPEYE HOLMES PARK  
CONCRETE WALKWAY  
RENOVATION**  
JEFFERSON COUNTY PRECINCT NO.3

This shall include any base section repairs that are necessary, in the opinion of the Engineer. There shall be no additional payment for damages to pavement or other structures.

10. Assume ownership for all excess or waste material, concrete, soils, or other debris and dispose of properly according to all State and Federal rules and regulations.
11. If overhead or underground power lines need to be de-energized/re-energized, contact the electrical service provider to perform this work. Costs associated with de-energizing/re-energizing the power lines or other protective measures required are at no expense to the County. If working near power lines, comply with the appropriate sections of Texas State Law and Federal Regulations relating to the type of work involved.
12. Material on hand will not be paid for.
13. Verify material quantities and dimensions prior to ordering materials.
14. The Contractor will establish the project control point, points, or tangency, PI's (points of intersection), point of curvature (PC, PI, and PT) and bench marks necessary to layout the project. Contractor shall establish and maintain these points throughout construction. There will be no separate payment for this work, but it shall be considered subsidiary to various bid items.
15. Any saw-cutting or other joint placement required for the project shall not be paid for directly but shall be considered subsidiary to various bid items.
16. The Contractor will notify the County 48 hours in advance of work.
17. Bidders should visit the proposed project site to acquaint themselves with the site conditions and access limitations prior to bidding on the project. Bidding on the project shall be considered the Contractor's assurance that he is familiar with the site conditions and that his bid provides for reasonable unanticipated conditions.
18. Sedimentation and environmental controls -
  - a. This item will not be paid for directly but considered subsidiary to various bid items.
  - b. The following temporary erosion, sediment and water control measures shall be required.
    - i. Contractor will be responsible for removing dirt from the roads and parking lots daily to prevent tracking.
    - ii. All concrete truck washout will be disposed of at the plant or in an Engineered approved containment area. The Containment area will be removed and disposed of once concrete placement is complete and the area restored to pre-construction conditions.
    - iii. Contractor shall police the construction area at the end of each day and remove and containerize all trash
    - iv. Pumped stormwater shall be channeled through a rock berm, erosion control log or other method to help prevent excessive discharge of silt.
      - i. Sedimentation and environmental controls -
19. All Bid Items shall be installed according to the TXDOT Item indicated in the plans and specifications per the 2014 TXDOT Standard Specifications for the Construction and Maintenance of Highways , Streets and Bridges.

**SPECIFICATIONS:**

**Bid Item 1 – Remove Existing Concrete Sidewalk - TXDOT Specification 104**

1. All concrete pavement will be saw cut full depth at connection points to existing pavements as noted on the drawings. Saw cutting of all concrete will not be measured or paid for directly but shall be considered subsidiary to various bid items.

**Bid Item 2 – 4” Concrete Sidewalk (in-place) – TXDOT Specification 360**

1. This bid item shall include all excavation, tree root removal, filling and compacting any ruts from tree root removal, filling and compacting of any soft spots. Fill ruts or soft spots with structural fill meeting the structural fill requirements shown on the plans. Payment for all excavation, tree root removal, filling or compacting associated with this item will be subsidiary to this item.
2. This bid item shall include all forming, joint placement, reinforcement, concrete placement, finishing and curing according to TXDOT Specification 360.
3. Sawing/Grooving of all joints shall begin as soon as sawing/grooving can be accomplished without damage to the pavement.
4. Class 5 self-leveling low modulus silicone sealant shall be used to seal expansion joints within repair areas on this project.
5. Saw cutting/grooving of all joints will not be paid for separately but shall be considered subsidiary to various bid items.
6. Light Broom Finish for final surface texture unless otherwise directed by the Engineer.
7. County shall be notified 48 hours prior to pouring concrete to inspect the subgrade and rebar installation. Bricks will not be allowed as chairs on this project. County shall be onsite for all pavement installation

**Bid Item 3 – Structural Fill**

1. Structural Fill meeting the requirements shown on the drawings shall be provided, installed and compacted to the density shown on the plans.
8. This bid item shall include the excavation, disposal of excavated materials, removal of tree roots necessary for the placement of the structural fill.
9. Payment for all excavation, tree root removal, filling or compacting and disposal of material associated with this item will be subsidiary to this item.

**Bid Item 4 – Temporary Brick Pavers**

1. Contractor shall provide and install Brick Pavers per the Attached Brick Specification for Pacific Clay Bricks (Bear Path:Dark Iron Spot) and shall install the bricks according to the Manufacturer Specifications, also attached.

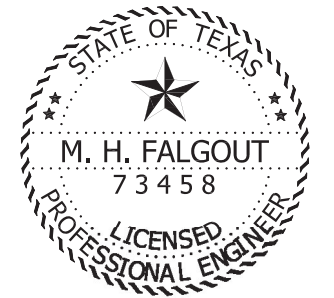

*Michelle Falgout* P.E.  
**M.H.FALGOUT**  
 REGISTERED PROFESSIONAL ENGINEER NO. 73458  
 DATE: 10-16-2024



**POPEYE HOLMES PARK  
 CONCRETE WALKWAY  
 RENOVATION**  
 JEFFERSON COUNTY PRECINCT NO.3

2. The lineal feet of brick pavers shown on the bid form is measured along the outside edge of the brick ledge as shown on the drawings. Bricks are expected to be placed with the long side perpendicular to the edge of the concrete as dictated by the plan details
3. Contractor will consult with the County regarding the color and texture of the bricks prior to placing order.

**Bid Item 5– Mobilization**

1. Establish and remove offices and facilities. Move personnel, equipment, and supplies to and from the project or the vicinity of the project site to begin work or complete work on Contract Items. Bonds and insurance are required for performing mobilization.
2. Mobilization shall not exceed three (3) percent of the total construction items amount prior to the cost of mobilization being added.

**WORK SEQUENCE/SCHEDULING:**

It shall be the responsibility of the Contractor to coordinate all work with the County and any other party affected by this project.

Contractor shall complete the work in 50 calendar days from the date of the notice to proceed.

Work may be performed between the hours of 7:00 am and 4:00 pm Monday through Thursday unless otherwise approved by Jefferson County.

**SUBMITTALS:**

Contractor shall submit the following submittals for review within 10 days of receiving the notice to proceed:

- 1 Concrete Mix Design;
- 2 Source and spec sheet for the structural fill;
- 3 Schedule showing estimated work times and sequencing of project.

During construction the Contractor shall provide the County with

1. Concrete Tickets
2. Structural Fill Tickets
3. Brick Delivery Tickets verifying the type of brick specified in the plans.

**1 YEAR WARRANTY**

Contractor will provide an Affidavit of Warranty at the end of the project. A copy of the Warranty document is attached to this Scope of work.

**END OF DIVISION I SCOPE OF WORK AND GENERAL NOTES AND SPECIFICATIONS**

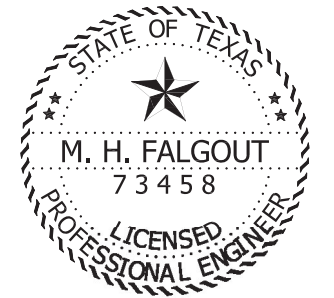

*Michelle Falgout* P.E.  
**M.H.FALGOUT**  
 REGISTERED PROFESSIONAL ENGINEER NO. 73458  
 DATE: 10-16-2024



**POPEYE HOLMES PARK  
 CONCRETE WALKWAY  
 RENOVATION**  
 JEFFERSON COUNTY PRECINCT NO.3

**Jefferson County  
2024 Popeye Holmes Park Concrete Walkway Renovation Project  
Summary of Bid Quantities**

Bid Item	Applicable Specification	BID ITEM DESCRIPTION	Unit	Quantity
1	TXDOT ITEM 104	REMOVE EXISTING CONCRETE SIDEWALK	SY	1687.0
2	TXDOT ITEM 360	4" CONCRETE WALKWAY (IN PLACE)	SY	1687.0
3	TXDOT ITEM 132	STRUCTURAL FILL (4" IN PLACE)	SY	1687.0
4	PAVER SPECIFICATIONS	BRICK PAVERS (IN PLACE)	LF	255.0
5	TXDOT ITEM 500	MOBILIZATION (MAX 3%)	LS	1.0

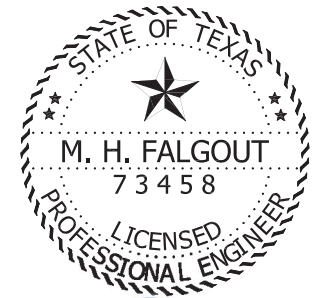

*Michelle Falgout* P.E.  
M.H.FALGOUT  
REGISTERED PROFESSIONAL ENGINEER NO. 73458  
DATE: 10-16-2024



JEFFERSON COUNTY

**POPEYE HOLMES PARK  
CONCRETE WALKWAY  
RENOVATION**  
JEFFERSON COUNTY PRECINCT NO.3

SHEET 1 OF 1 Page 69 of 72

DESIGN	J.D.	QUANTITY SUMMARY	SHEET NO.
CHECKED	M.F.		5

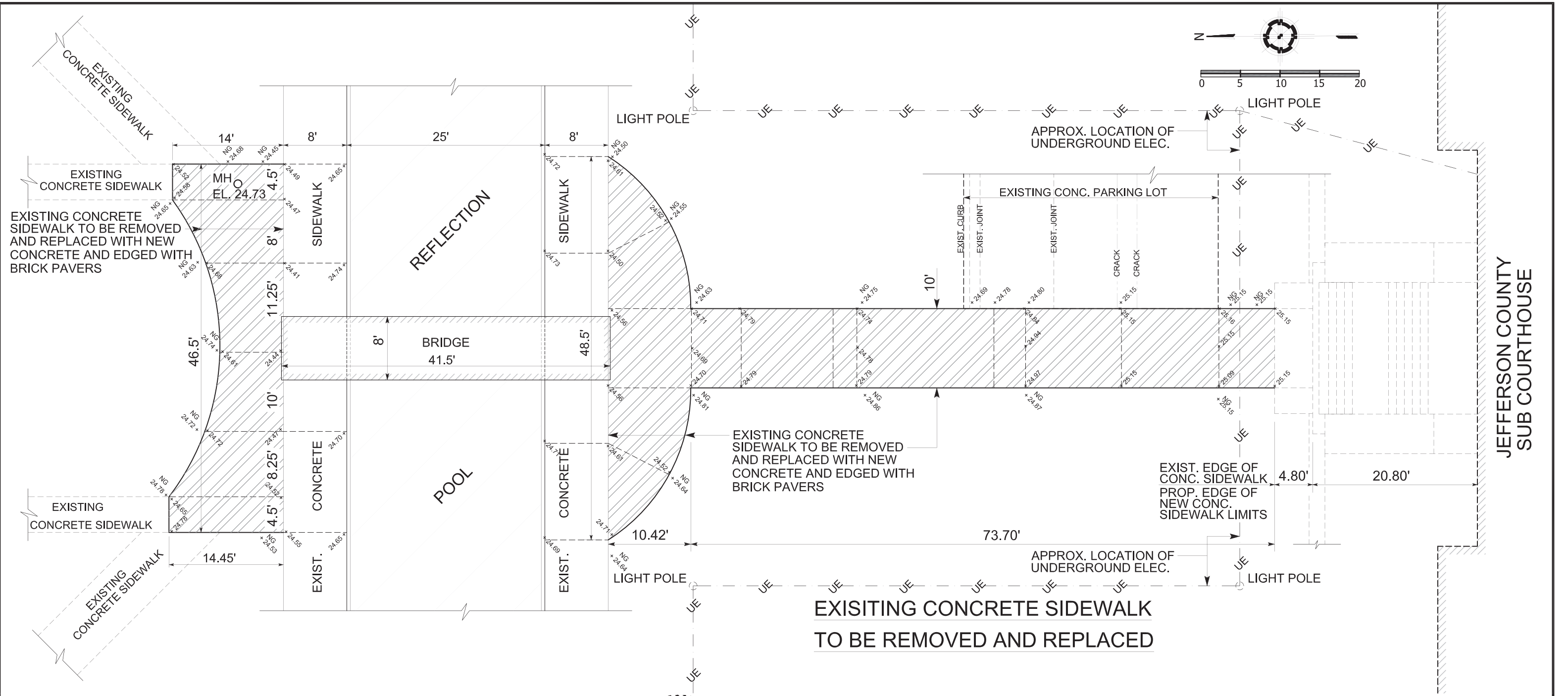

EXISTING CONCRETE SIDEWALK TO BE REMOVED AND REPLACED WITH NEW CONCRETE AND EDGED WITH BRICK PAVERS

EXISTING CONCRETE SIDEWALK TO BE REMOVED AND REPLACED WITH NEW CONCRETE AND EDGED WITH BRICK PAVERS

EXISTING CONCRETE SIDEWALK TO BE REMOVED AND REPLACED

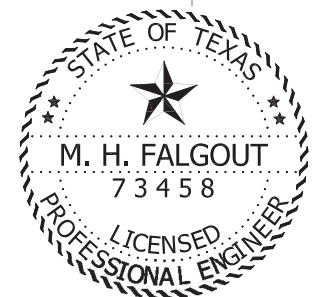

*Michelle Falgout* P.E.  
**M.H.FALGOUT**  
 REGISTERED PROFESSIONAL ENGINEER NO. 73458  
 DATE: 10-16-2024

- NOTES:**
- 1) CONTRACTOR TO FULL DEPTH SAW CUT ALL EDGES AGAINST EXISTING CONCRETE WHERE EXISTING CONCRETE WILL BE REMOVED.
  - 2) ANY DAMAGE TO THE EXISTING CONCRETE PAVING OR ANY OTHER STRUCTURES WILL BE REPAIRED TO EXISTING OR BETTER CONDITION AT NO EXPENSE TO THE COUNTY.

JEFFERSON COUNTY TEXAS

JEFFERSON COUNTY

**POPEYE HOLMES PARK  
 CONCRETE WALKWAY  
 RENOVATION**

JEFFERSON COUNTY PRECINCT NO.3

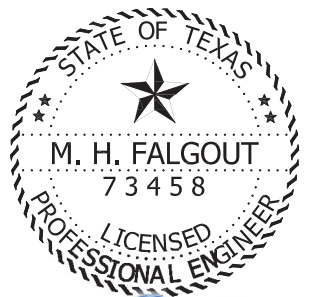
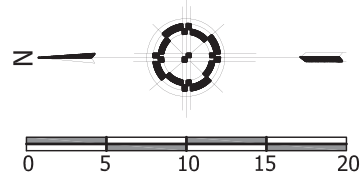
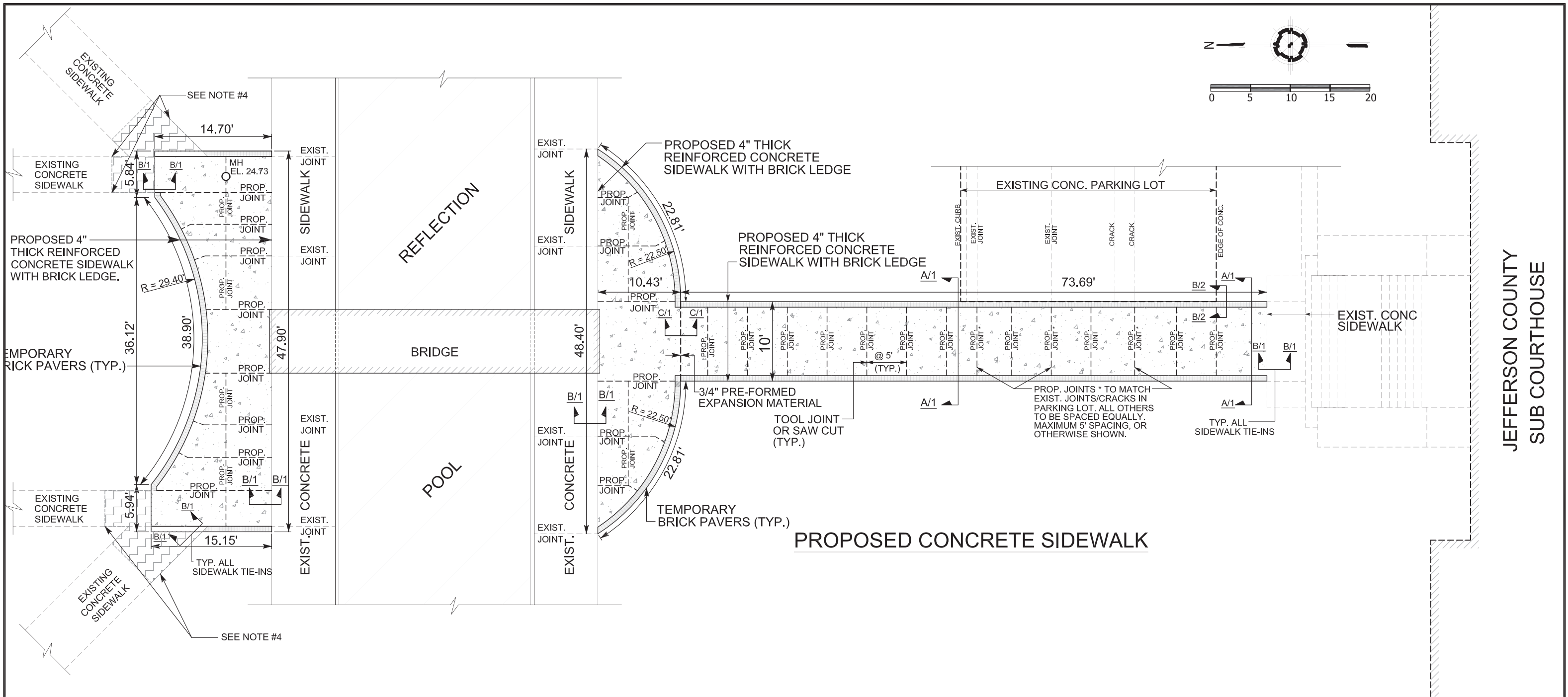

*Michelle Falgout*  
M.H.FALGOUT P.E.

REGISTERED PROFESSIONAL ENGINEER NO. 73458  
DATE: 10-16-2024

- NOTES:**
- 1) CONTRACTOR TO MATCH EXISTING SIDEWALK AND PARKING LOT GRADES WHEN TYING TO EXISTING SIDEWALK AND PARKING LOT.
  - 2) INSTALL TEMPORARY BRICK PAVERS PER MANUFACTURERS RECOMMENDATIONS.
  - 3) LIGHT BROOM FINISH FOR FINAL SURFACE TEXTURE.
  - 4) SIDEWALK PANELS TO BE LIFTED BY OTHERS PRIOR TO THIS WORK.
  - 5) JOINT LAYOUT TO BE VERIFIED WITH ENGINEER.



**POPEYE HOLMES PARK  
CONCRETE WALKWAY  
RENOVATION**  
JEFFERSON COUNTY PRECINCT NO.3

SHEET 1 OF 1



BACKFILL FORMED EDGES WITH COMPACTED STRUCTURAL FILL.

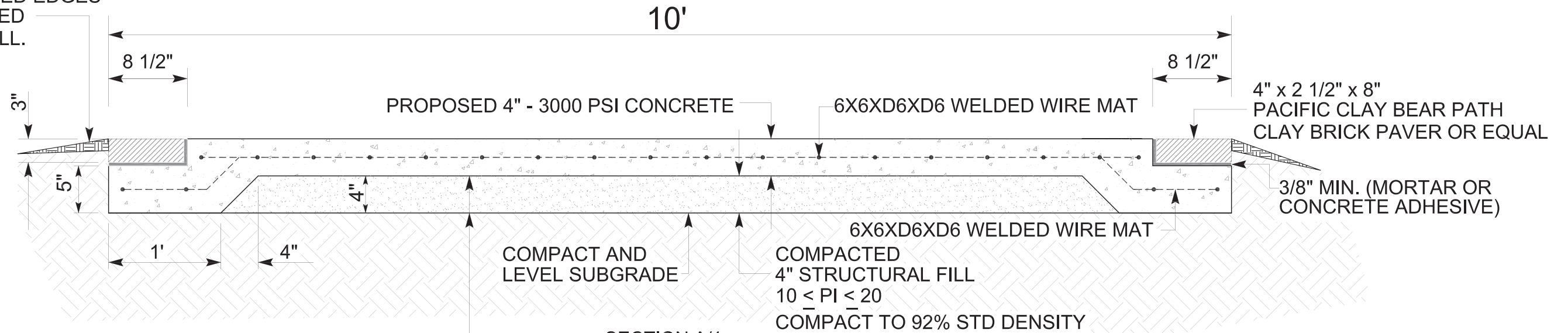

SEE NOTE \*1 FOR AREA PREPARATION

SECTION A/1  
NTS

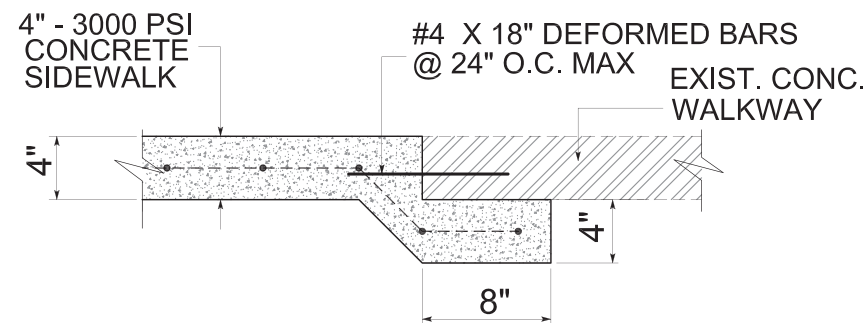

SECTION B/1  
NTS

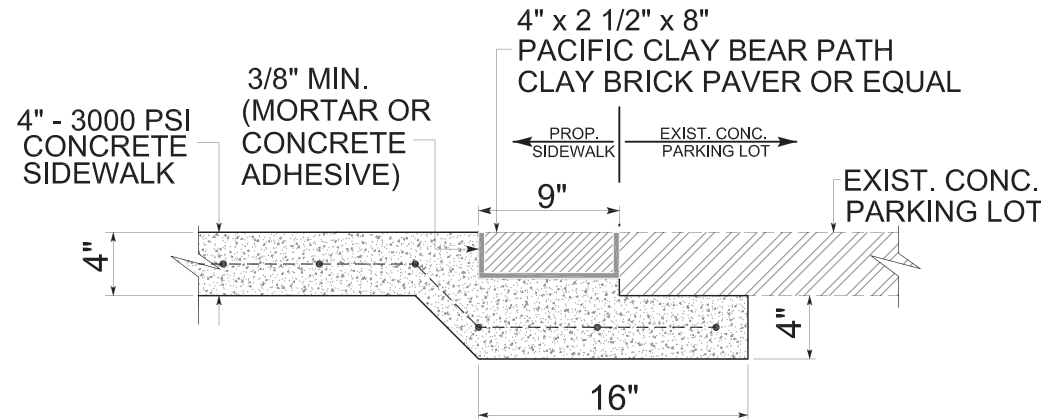

SECTION B/2  
NTS

\*NOTE: SECTION ALONG EXISTING CONCRETE PARKING LOT.

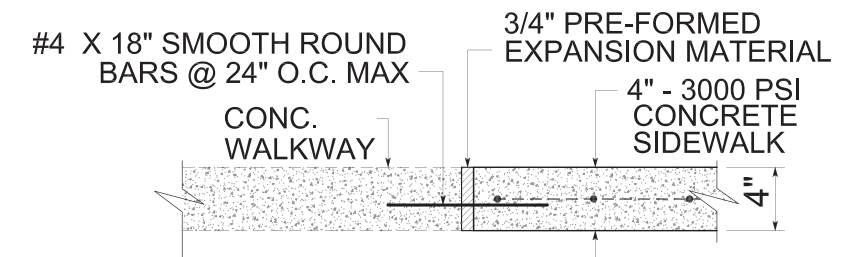

SECTION C/1  
NTS

**NOTES: AREA PREPARATION**

- 1) CUT AND REMOVE OR GRIND DOWN ROOTS TO THE LIMITS SHOWN FOR STRUCTURAL FILL AND AND CONCRETE REPLACEMENT.
- 2) ROOTS SHALL NOT BE RIPPED OR TORN.

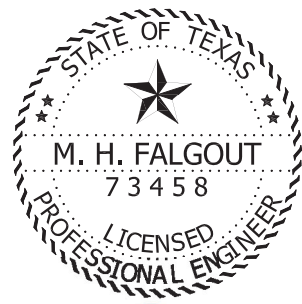

*Michelle Falgout* P.E.  
M.H.FALGOUT  
REGISTERED PROFESSIONAL ENGINEER NO. 73458  
DATE: 10-16-2024

**NOTES:**

- 1) AFTER REMOVAL OF THE EXISTING CONCRETE SIDEWALK, CONTRACTOR TO LEVEL AND COMPACT THE AREA TO NATURAL DENSITY (87%). USE STRUCTURAL FILL TO LEVEL, SHAPE AND FILL RUTS.
- 2) LIGHT BROOM FINISH FOR FINAL SURFACE TEXTURE.



JEFFERSON COUNTY

**POPEYE HOLMES PARK  
CONCRETE WALKWAY  
RENOVATION**  
JEFFERSON COUNTY PRECINCT NO.3

SHEET 1 OF 1